

|   |            |  |            |
|---|------------|--|------------|
| <b>WELCOME &amp; INTRODUCTION</b> ..... | <b>1-1</b> | Facts about LPG .....                      | 6-3        |
| End Of Life Vehicle Directive .....     | 1-1        | Awning Spaces, LPG and Appliance           |            |
| Erwin Hymer Group UK Technical          |            | Exhaust .....                              | 6-3        |
| Approvals .....                         | 1-2        | LPG Gas System .....                       | 6-3        |
| <b>GENERAL SAFETY</b> .....             | <b>2-1</b> | Guidelines for the Safe Refuelling of      |            |
| Please read before using your new       |            | Autogas Vehicles .....                     | 6-4        |
| campervan. ....                         | 2-1        | Gas Supply .....                           | 6-6        |
| Proper And Safe Use Of Storage          |            | Connection .....                           | 6-6        |
| Areas In Campervans .....               | 2-1        | Gas Regulator .....                        | 6-6        |
| Ventilation .....                       | 2-2        | Gas Operation .....                        | 6-7        |
| High-Level Ventilation .....            | 2-2        | Water System .....                         | 6-7        |
| Low-Level Ventilation .....             | 2-2        | Filling your fresh Water Tank .....        | 6-7        |
| Ventilation in Separate Bedrooms .....  | 2-2        | Waste Water Tank .....                     | 6-7        |
| Gas Dispersal Holes .....               | 2-2        | Draining Down Your Water System .....      | 6-7        |
| Fire Safety .....                       | 2-2        | <b>ELECTRICAL SYSTEM</b> .....             | <b>7-1</b> |
| Fire Extinguishers .....                | 2-2        | Battery Installation .....                 | 7-1        |
| In Case Of Fire .....                   | 2-2        | Battery Maintenance .....                  | 7-1        |
| Fire Retardant Foams .....              | 2-2        | Generators / Charger .....                 | 7-2        |
| <b>PREPARING FOR THE ROAD</b> .....     | <b>3-1</b> | 230v Power Supply .....                    | 7-2        |
| campervan Weights Explained .....       | 3-1        | Mains Unit .....                           | 7-2        |
| Mass in Running Order .....             | 3-1        | Resetting the RCD .....                    | 7-2        |
| Maximum Technically Permissible         |            | Automatic Charging System .....            | 7-2        |
| Laden Mass .....                        | 3-1        | Schaut WA 121525 Booster Unit .....        | 7-3        |
| User Payload .....                      | 3-1        | General .....                              | 7-3        |
| Loading .....                           | 3-1        | Function .....                             | 7-3        |
| Before Moving Off .....                 | 3-1        | Location .....                             | 7-3        |
| Pulling Off .....                       | 3-2        | Internal Lighting .....                    | 7-3        |
| Bicycle Racks .....                     | 3-2        | Maximum Power Ratings for Internal         |            |
| <b>MOTORWAY HANDLING</b> .....          | <b>4-1</b> | Lights .....                               | 7-3        |
| Best Practice .....                     | 4-1        | <b>HOW TO USE YOUR CAMPERVAN'S</b>         |            |
| Speed Limits .....                      | 4-1        | <b>EQUIPMENT</b> .....                     | <b>8-1</b> |
| Towing Your Campervan .....             | 4-1        | Control Panel .....                        | 8-2        |
| <b>ARRIVING ON SITE</b> .....           | <b>5-1</b> | Vegas Button Control Panel .....           | 8-2        |
| Check Site Regulations .....            | 5-1        | Vegas Voltmeter without Water or           |            |
| Selecting A Pitch .....                 | 5-1        | Gas Level .....                            | 8-3        |
| Lateral Levelling (Side To Side) .....  | 5-1        | Whale Heat Control .....                   | 8-4        |
| Leveller Jack .....                     | 5-1        | Troubleshooting - Whale Heat Control ...   | 8-6        |
| Ramp .....                              | 5-1        | Maintenance / Repairs .....                | 8-8        |
| <b>GETTING STARTED</b> .....            | <b>6-1</b> | Whale Heat Control Panel Operation .....   | 8-9        |
| Electricity .....                       | 6-1        | Electric Power Management .....            | 8-11       |
| Power Supply Charger .....              | 6-1        | Troubleshooting - Whale Heat               |            |
| 12v Systems: .....                      | 6-1        | Control Panel .....                        | 8-12       |
| Generator/Charger .....                 | 6-1        | Maintenance / Repairs .....                | 8-13       |
| Electricity Mains Supply .....          | 6-1        | Operating Instructions - Drain Valve ..... | 8-14       |
| Connecting To Mains Supply On           |            | Winterising .....                          | 8-14       |
| Arrival at Site .....                   | 6-1        | Oven .....                                 | 8-15       |
| Disconnecting Mains Supply When         |            | Safety .....                               | 8-15       |
| Leaving Site .....                      | 6-2        | Before Use .....                           | 8-16       |
| Overseas Electrical Connection .....    | 6-2        | Maintenance and Cleaning .....             | 8-17       |
|   |            | Troubleshooting .....                      | 8-17       |

# CONTENTS

|   |      |   |             |
|---|------|---|-------------|
| Triplex .....   | 8-18 | Wing Omni-Directional TV Antenna .....  | 8-50        |
| Main Components .....                                   | 8-18 | Operating Instructions .....            | 8-50        |
| Use of the Burners .....                                | 8-19 | Changing the slant of the Antenna ..... | 8-50        |
| Use of the Electric Hotplate<br>(if applicable) .....   | 8-19 | Wiring Connections .....                | 8-50        |
| Use of the Grill .....                                  | 8-20 | Thule Step .....                        | 8-51        |
| Use of the Oven .....                                   | 8-20 | Operation .....                         | 8-51        |
| Safe Cooking .....                                      | 8-21 | Safety Instructions .....               | 8-51        |
| Temperature Control .....                               | 8-22 | Maintenance .....                       | 8-51        |
| Refrigerator .....                                      | 8-23 | Whale Easi-Slide Socket .....           | 8-52        |
| Main Components .....                                   | 8-24 | Safety Information .....                | 8-52        |
| Control Panel .....                                     | 8-24 | Safety .....                            | 8-52        |
| Switching on the Refrigerator .....                     | 8-24 | Mobile Internet (Option) .....          | 8-53        |
| Selecting Cooling Level .....                           | 8-24 | <b>SECURITY .....</b>                   | <b>9-1</b>  |
| Selecting Night Mode .....                              | 8-25 | Tracker (Option) .....                  | 9-1         |
| Use of the Frozen Food Compartment ..                   | 8-25 | Campervan Theft .....                   | 9-1         |
| While Driving .....                                     | 8-25 | <b>CARE OF YOUR CAMPERVAN .....</b>     | <b>10-1</b> |
| Troubleshooting .....                                   | 8-26 | Exterior Body Shell .....               | 10-1        |
| Microwave (Where Fitted) .....                          | 8-27 | Acrylic Windows .....                   | 10-1        |
| Smoke Alarm .....                                       | 8-28 | Window Blinds & Flyscreens .....        | 10-1        |
| Carbon Monoxide Alarm .....                             | 8-30 | ABS - Components .....                  | 10-1        |
| Rooflights .....  | 8-34 | Interior Walls .....                    | 10-1        |
| MPK Rooflight (Where Fitted) .....                      | 8-34 | Furniture .....                         | 10-1        |
| Midi Heki Rooflight (Where Fitted) .....                | 8-35 | Taking Care of your Upholstery: .....   | 10-1        |
| Door Flyscreen .....                                    | 8-35 | Washroom And Handbasin Fittings .....   | 10-2        |
| Shower .....  | 8-36 | Shower Trays .....                      | 10-2        |
| Taps .....  | 8-36 | Water Systems .....                     | 10-2        |
| Kitchen Taps .....                                      | 8-36 | Water Containers .....                  | 10-3        |
| Internal Doors .....                                    | 8-37 | Internal Water Systems .....            | 10-3        |
| Toilet/Shower Room Doors .....                          | 8-37 | Thetford Toilet .....                   | 10-3        |
| Other Internal Doors .....                              | 8-37 | Changing a Wheel .....                  | 10-3        |
| Magnetic Catches (Where Fitted) .....                   | 8-37 | Tyres & Tyre Pressures .....            | 10-3        |
| Paddle Latch .....                                      | 8-37 | Tyre Wear and Damage .....              | 10-3        |
| Concealed Latch .....                                   | 8-37 | Pre-season Water System Preparation ..  | 10-4        |
| Thetford C-260 Cassette Toilet Range ..                 | 8-38 | Getting Ready for the Winter .....      |             |
| Introduction .....                                      | 8-38 | <b>STORAGE .....</b>                    | <b>11-1</b> |
| Preparing for Use (Standard) .....                      | 8-38 | Long Term & Winter Storage .....        | 11-1        |
| Using the Toilet (Standard) .....                       | 8-38 | Campervan Covers .....                  | 11-1        |
| Emptying .....  | 8-40 | Battery Maintenance .....               | 11-1        |
| Emptying with Optional Features .....                   | 8-40 | <b>CAMPERVAN HABITATION</b>             |             |
| Cleaning and Maintenance .....                          | 8-41 | <b>WARRANTY COVER .....</b>             | <b>12-1</b> |
| Toilet Bowl .....                                       | 8-41 | non warranty repairs .....              | 12-3        |
| Waste Holding Tank .....                                | 8-41 | Remedial Work .....                     | 12-4        |
| Cleaning and Maintenance for<br>Optional Features ..... | 8-42 | <b>CAMPERVAN CONSTRUCTION -</b>         |             |
| Winter Operation .....                                  | 8-42 | <b>MAIN COMPONENTS .....</b>            | <b>13-1</b> |
| Storage .....   | 8-42 | Windows .....                           | 13-1        |
| Toilet Unit Malfunctions .....                          | 8-42 | Insulation .....                        | 13-1        |
| How To Make Up Your Beds .....                          | 8-44 | .....                                   | 13-1        |
| How to use your Pop Top -<br>(Where Applicable) .....   | 8-47 | <b>ELECTRICAL DRAWINGS .....</b>        | <b>14-1</b> |

|   |             |
|---|-------------|
| <b>GENERAL QUESTIONS .....</b>                              | <b>15-1</b> |
| <b>GLOSSARY .....</b>                                       | <b>16-1</b> |
| <b>CAMPERVAN ANNUAL SERVICE<br/>RECORD .....</b>            | <b>17-1</b> |
| Annual Habitation Service Records .....                     | 17-4        |
| <b>NOTIFICATION OF CHANGE OF<br/>OWNERSHIP .....</b>        | <b>18-1</b> |
| <b>NOTIFICATION OF CHANGE TO<br/>NAME AND ADDRESS .....</b> | <b>19-1</b> |
| <b>INDEX .....</b>  | <b>20-1</b> |



## WELCOME & INTRODUCTION

Thank you for selecting your new campervan.

Before you drive off, please familiarise yourself with the campervan and read this owners' handbook. This will help you to obtain the maximum pleasure from your vehicle and avoid endangering yourself and others.

Additional information and detailed appliance instruction manuals are also contained in your Owner's Information Pack.

**Your new campervan has been designed as a recreational vehicle and is intended for recreational use only. It is not intended for business use or for permanent habitation. Erwin Hymer Group UK accepts no liability if the campervan is used for any purpose other than recreational/holiday use. Any use other than recreational/holiday use will invalidate your warranty.**

**Please note:** All Erwin Hymer Group UK campervans are thermal tested to ensure compliance with British and European standard BS EN 1646 part 1.

By following the instructions provided in this handbook and maintaining your campervan in a first class roadworthy condition, you are sure to have many years of carefree use. To ensure the very best quality and reliability all campervan designs and new developments are rigorously tested. Therefore Erwin Hymer Group UK will accept no liability or uphold the warranty if the campervan is altered or modified in any way.

### IMPORTANT

The VIN number of your campervan must be quoted in all correspondence, it can be found on a plate fixed next to the chassis plate within the engine compartment.

There is also a VIN number on the chassis cab windscreen, which should be quoted in any communications with Fiat.

Changing market and supply situations may prevent us from maintaining the exact specification details in this guide and we therefore reserve the right to alter

specifications as materials and conditions demand and if necessary supply an alternative.

***Enjoy your new campervan.***

**IMPORTANT: Register your vehicle with us**

**In order to fully protect your valuable purchase, we would kindly ask you to take a few moments to complete our online Warranty Registration.**

Registering your vehicle will ensure that we always have the most accurate and up-to-date contact information and all of your vehicle details to hand, should you ever need our assistance.

Your feedback is incredibly important to us and helps shape the future of our leisure vehicles. We would be delighted if you would also complete our accompanying online Customer Questionnaire.

Both our **Registration** form and our **Customer Questionnaire** can be found on our Homepage: [www.elddis.co.uk](http://www.elddis.co.uk)

**Please note that this is not for warranty purposes, warranty registrations must be done by the selling retailer.**

### End Of Life Vehicle Directive

Your new campervan fully complies with the European Directive on the End of Life Vehicles. In order to obtain information on how to dispose of your campervan at the end of its life please visit the Fiat website. The Fiat website contains full details on all Fiat products together with details of their environmental and recycling policies. The site address is [www.fiat.co.uk](http://www.fiat.co.uk).

## **Erwin Hymer Group UK Technical Approvals**

All Erwin Hymer Group UK campervans have been European Commission Whole Vehicle Type approved. In order to ensure your new campervan is safe to use Erwin Hymer Group UK are members of and have been inspected by the following bodies.

NCC who operate a certification scheme to ensure compliance with the European safety standards for campervans.

Erwin Hymer Group UK has also obtained ISO 9001:2015 accreditation and this is periodically audited.

**Please note:** All Campervans manufactured by Erwin Hymer Group UK are designated by their model year. For example, 2022 Model year runs from 1st September 2021 to 31st August 2022.

## GENERAL SAFETY

### Please read before using your new campervan.

In order for you to get the most out of your new campervan it is necessary for you to be aware of the following:

- (i) Do not obstruct ventilators (See Safety Section - Ventilation)
- (ii) Inspect the flexible gas hose regularly for deterioration and renew as necessary, with approved type, as and in any case no later than the expiry date stated on the hose.
- (iii) Never use portable cooking or heating equipment inside your campervan. Do not use your fitted cooking equipment as heating at any time.
- (iv) Never allow modification to your gas or electrical system unless qualified persons carry them out. A Gas Safe Register™ approved gas fitter should carry out all modification to the gas system. Any modifications carried out on the electrical system should be carried out by a suitably qualified electrician.
- (v) Never exceed your campervan's Maximum Technical Permissible Laden Mass.
- (vi) Never exceed the front or rear axle maximum load as specified by the Fiat weight plate under the bonnet.
- (vii) Pull out/lift up worktop extensions, where fitted, are only designed to take maximum weight of 6kgs.
- (viii) Please ensure extra care when young children use high level bunks and always use the safety nets and lift up flaps provided.
- (ix) Do not leave children under 14 years of age unattended in your campervan.
- (x) Please ensure all gas appliances are turned off while you are travelling.
- (xi) If you suspect there is a gas leak please open all the windows then vacate the campervan. Switch off the gas supply if it is safe to do so. Then contact your nearest Erwin Hymer Group UK Retailer to arrange for them to check the gas system.
- (xii) Only those seats designated for travelling should be occupied when the campervan is in motion.

- (xiii) Please note that campervans are covered by the seat belt regulations, which came into force in October 2006. These require children that are under 12 years old and also under 135cm in height to be seated in either child seats or on bolster cushions.
- (xiv) Before travelling in your campervan: Ensure all the tables have been stored in their designated table storage position.
- (xv) Ensure you remove all items from the microwave before travelling.
- (xvi) It is essential that you have securely closed and locked the habitation door before setting off on any journey.
- (xvii) Care is to be taken when mounting and dismantling the toilet due to its elevated height.
- (xviii) Turning OFF the internally mounted gas taps is an accepted method of isolating the gas system whilst travelling.

### Proper And Safe Use Of Storage Areas In Campervans

The storage areas provided in your campervan are designed solely for the purpose of carrying personal possessions; these areas must not be used:

- As a habitation area (e.g. living, sleeping or cooking).
- To carry passengers, animals or livestock.
- For the installation (or use) of any LPG gas operated appliances, (unless supplied fitted by the manufacturer).
- For carrying LPG gas bottle cylinders, (unless designated by the manufacturer).
- To carry any flammable liquids, (unless properly stored, sealed and secured).
- For the operation of an electrical generator.
- In such a way that the loading exceeds the payload limit, as defined by the manufacturer.
- Such that the weight distribution of the vehicle means non-compliance with the vehicle axle loads.

## **VENTILATION**

All campervans manufactured by Erwin Hymer Group UK are ventilated at both high and low level in accordance with BS EN 721 Safety Ventilation. The fixed ventilation points fitted in your campervan must not be blocked under any circumstances as your safety may depend upon them. It is advisable that the fixed ventilation points are checked and cleaned (where necessary) on a regular basis.

### **High-Level Ventilation**

This is mainly provided by fixed ventilation within the fitted roof skylight. These roof skylights should be cleaned annually by use of a small brush to remove any dust that may have accumulated around the mesh fitted. On some roof skylights the mesh can be easily removed to aid cleaning. On fan-assisted roof skylights it is essential that the fan is switched off prior to cleaning.

High level ventilation may also be provided by additional fitted mushroom vents.

### **Low-Level Ventilation**

All Erwin Hymer Group UK campervans have fixed low level ventilation provided. These ventilators are covered with plastic covers designed to prevent them from being obstructed by items placed within the bed box. These covers can be removed by undoing the two screws in order to facilitate cleaning the ventilators, however these covers must be replaced once cleaning is completed.

It is essential for your safety that these ventilators are not blocked at any time.

### **Ventilation in Separate Bedrooms**

In campervans with separated sleeping areas, separate ventilation is required and is provided via a roof skylight at high level and a ventilator at low level.

### **Gas Dispersal Holes**

All appliances and gas unions have a gas dispersal hole within the same compartment. It is essential that these are not blocked or made ineffective.

## **FIRE SAFETY**

### **Fire Extinguishers**

It is recommended that one dry powder fire extinguisher complying with EN 3-7 of at least 1kg capacity or equivalent is provided by the main door and a fire blanket next to the cooker. Familiarise yourself with the instruction on your fire extinguisher and the local fire precaution arrangements.

### **In Case Of Fire**

- (i) Get everyone out of the campervan as quickly as possible using whichever exit is quickest including windows. Do not stop to collect any personal items.
- (ii) Raise the alarm. Call the fire brigade.
- (iii) Turn off gas container valve if safe to do so.
- (iv) Retreat to a safe distance.

### **Fire Retardant Foams**

All campervans are equipped with Polyurethane (PU) foam which are combustion modified foam cushions, sprung mattresses and fire retardant fabric. All furnishings and fabrics used by Erwin Hymer Group UK comply with the Furniture and Furnishings (Fire Safety) Regulations. In addition all upholstery is made of fire retardant fabric.



## PREPARING FOR THE ROAD

Before venturing out on to the road with your campervan, it is important that you prepare correctly.

### CAMPERVAN WEIGHTS EXPLAINED

#### Mass in Running Order

The weight of your campervan as it leaves the factory, as new with standard fixtures and fittings, plus an allowance for the driver of 75kgs, the mass of the fuel (diesel) when the tank is 90% full and an allowance of 12kg for a full gas tank.

#### Maximum Technically Permissible Laden Mass

The maximum mass the vehicle can be when fully laden for use on the road.

#### User Payload

The load margin (payload), this represents the difference between the Mass in Running Order and the Maximum Technically Permissible Laden Mass. It shows the maximum weight that can be loaded into your campervan, covering items such as food, crockery, cutlery, clothing, bedding, etc.

#### Loading

It should be noted that even weight distribution is a major factor in making your campervan an easy and pleasant vehicle to drive. Care should therefore be taken in balancing the load, ensuring that heavy items are well spaced and are in as low a position as possible, for example, low cupboards and bed boxes.

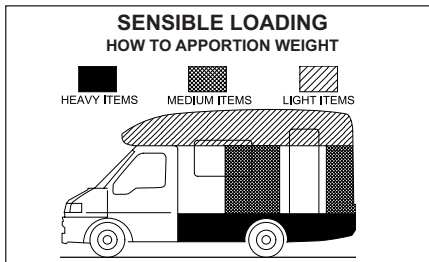

**Note:** Light items are considered as clothing and bedding. It is not recommended to travel with tinned items in overhead lockers.

**IMPORTANT: Do not exceed maximum technical permissible laden mass for your campervan.**

## BEFORE MOVING OFF

Whenever making a journey with your campervan, either setting off on holiday or returning home, it is good practice to run through this simple checklist.

- (i) Close and secure all cupboards and drawers and secure any loose articles.
- (ii) Do not store tins, bottles, etc. in overhead lockers.
- (iii) **Close and secure all windows and roof lights.**
- (iv) Leave all curtains and blinds open to aid visibility.
- (v) Turn off all gas appliances.
- (vi) Switch off 240volt supply at source; disconnect mains cable and store in an appropriate place.
- (vii) Check the battery is secure and that the vent pipe is firmly attached to the battery and exits outside of the vehicle.
- (viii) Ensure the fridge is on 12V operation and door lock is set. (Note: the electrical relays will allow the fridge to be run on the vehicle battery when the engine is running.)
- (ix) Remove any external fresh water connections etc.
- (x) Make sure any heavy articles are stored in accordance with the loading procedure.
- (xi) Lock habitation doors when travelling. We would recommend that all exterior doors, including the entrance door and access doors are firmly closed and locked prior to your departure.
- (xii) Check your external rear view mirrors and adjust if necessary.
- (xiii) If a step is used, ensure it is put away before moving off.
- (xiv) Your new Erwin Hymer Group UK campervan has been designed to carry passengers in designated passenger seats only. The fitting of a 3-point seat belt can identify these seats. Any seat not fitted with a 3 point seat belt is not designated as a passenger seat.

- (xv) Ensure all tables have been stored in their designated table storage position.
- (xvi) Ensure you remove all items from the microwave (if fitted).
- (xvii) Check all the road lights are operational.
- (xviii) Ensure the hob lid is in the closed position.

### **Pulling Off**

- Pull away smoothly.
- Avoid wear and tear on clutch and transmission by taking extra care.
- Change gears smoothly.
- Try not to jerk the clutch.

### **Bicycle Racks**

Fitting a bicycle rack to the rear of a campervan will affect how weight is distributed. There are restraints to be aware of with such fitments.

The maximum loading allowed on the rear is 35 kgs including the weight of the bike rack and bicycles.

The campervan must also be balanced to take into account the new weight distribution. Weight must be distributed evenly.

Erwin Hymer Group UK cannot be held responsible for problems related to a bicycle rack fitted by a third party.

## **MOTORWAY HANDLING**

### **Best Practice**

To gain the most enjoyment and ensure a long life for your campervan, the following should be observed:

- Do not bump kerbs with wheels.
- When overtaking ensure sufficient clearance is given to other vehicles.
- Your campervan will not accelerate as quickly as a car, so take this into account when attempting to overtake other vehicles.
- Carry out all manoeuvres as smoothly as possible.
- Use the wing mirror to check your campervan has cleared the other vehicle.
- Slow down and take care when driving over raised speed bumps, 'sleeping policemen' or when embarking/ disembarking ferries.
- In high or cross winds, travelling downhill or in conditions of poor visibility reduce your speed.
- High-sided vehicles can cause air buffeting so extra care must be taken when passing or being passed. Leave as much space as possible when overtaking these types of vehicles

### **Speed Limits**

Be sure to observe all statutory speed limits and adapt your speed to take account of prevailing weather and road conditions.

### **Towing Your Campervan**

In the unlikely event that you have to tow your campervan. Please refer to the base vehicle information for details on where to find the tow point and tow hook.



## ARRIVING ON SITE

### CHECK SITE REGULATIONS

On arrival at a campsite, you should always check the site regulations. This will help avoid any unnecessary conflict with site management and other site users.

### SELECTING A PITCH

Carefully select where you wish to place your campervan. The site should be as level as possible, preferably not under or near trees, well drained and away from possible boggy areas. Consider how you will move the campervan when it is time to leave the site. On sloping ground it is better to pitch facing downhill, especially during wet weather.

### LATERAL LEVELLING (SIDE TO SIDE)

A quick glance at your pitch should tell you if you are likely to need side to side levelling i.e. levelling across the axle. On uneven ground lateral levelling is accomplished by the use of a leveler jack or ramp and a spirit level placed 'across' the campervan floor.

### LEVELLER JACK

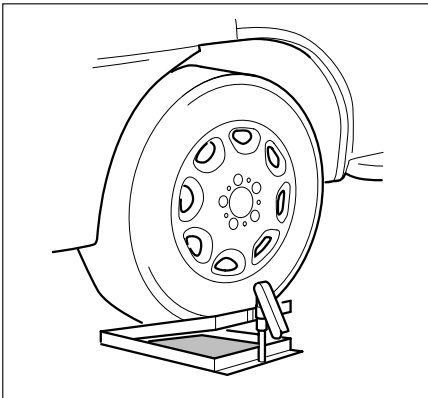

Place the leveler jack, folded flat, in front of the wheel that is to be raised to level the axle. Drive the campervan onto the leveler jack and adjust the height until the spirit level shows that the campervan is laterally level.

### RAMP

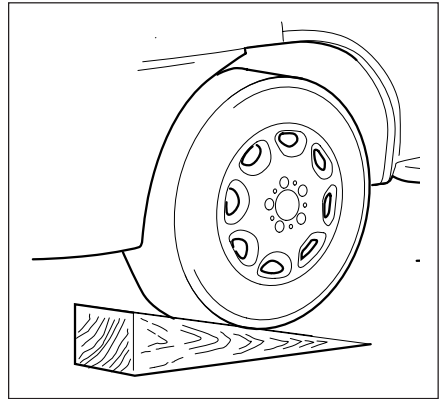

Reverse onto your pitch about a foot further back than you wish to end up. Then place the levelling ramp in front of the wheel that needs to be raised.

Place a spirit level parallel to the axle or just inside the campervan door. It helps to have two people at this point. One should drive the campervan very slowly forward moving the wheel up the ramp and the other should indicate when the spirit level bubble is in the middle.

Whichever method you use, once level, apply the campervan handbrake and chock the campervan wheel if necessary.



## GETTING STARTED

You have arrived at your destination and now want to start to enjoy your new campervan. The following is a step by step guide to connecting your services and getting everything in your campervan working.

### ELECTRICITY

#### Power Supply Charger

Your campervan is fitted with a power supply/charger. This will charge the leisure battery "where supplied" when fitted and also power the 12V systems.

A leisure battery must be fitted to the campervan at all times when in use.

Whilst the charging voltage of the auxiliary battery is 13.8 volts, the units will not overcharge a battery in good condition. This however, is not the case when a battery is faulty, as increased gassing and battery fluid loss can occur when attempting to recharge the battery.

#### 12v Systems:

When connected to the 230V site supply the automatic Power Supply/Charger will charge the leisure battery and power the 12V systems.

When the ignition is switched on the 12V system in the campervan is automatically switched off, vehicle power is supplied to the refrigerator.

### GENERATOR/CHARGER

When connecting to a generator, always switch off the RCD, start the generator and allow running for a few minutes to stabilise. When this has happened, switch the RCD to the ON position.

### ELECTRICITY MAINS SUPPLY

Your campervan's main electrical installation is designed to run on 230V at 50 hertz AC supply.

### CONNECTING TO MAINS SUPPLY ON ARRIVAL AT SITE

Before connecting the campervan installation to the mains supply, check that:

- (i) The mains supply is suitable for your installation and appliances, i.e. whether it is AC or DC and whether it is at the correct voltage and frequency.

- (ii) Your campervan is properly earthed. Never accept a supply from a socket outlet or plug having only two pins, or from a lighting outlet.
- (iii) Any residual current device (earth leakage circuit breaker) in the mains supply to the campervan has been tested within the last month. In case of doubt, consult the site owner or their agent.
- (iv) Make sure that the switch at the site supply point is off and that all electrical equipment in the campervan is switched off by ensuring your campervan mains isolating switch on the RCD is in the 'OFF' position.

Once the above checks have been made:

- (v) Remove any cover to the electricity inlet provided on the campervan and insert the female connector of the flexible orange supply cable as shown.

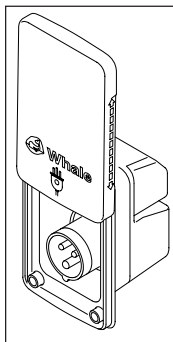

- (vi) Locate the site supply and remove any cover from the socket outlet provided at the supply point. Insert the male plug at the other end of the flexible orange supply cable. Switch on the main switch at the site supply point (if appropriate).

- (vii) Place any surplus cable under the campervan. Ensure that the surplus cable is not coiled up as it could overheat.

- (viii) The MCB main electricity supply switch should be put in the 'ON' position.
- (ix) Check the RCD is working by pressing the test button. Once pressed all electrical lights and appliances should cease to operate. Reset and then check the electrical system is operational.

## WIRING OF CONNECTING CABLE AND CAMPERVAN MAINS INLET

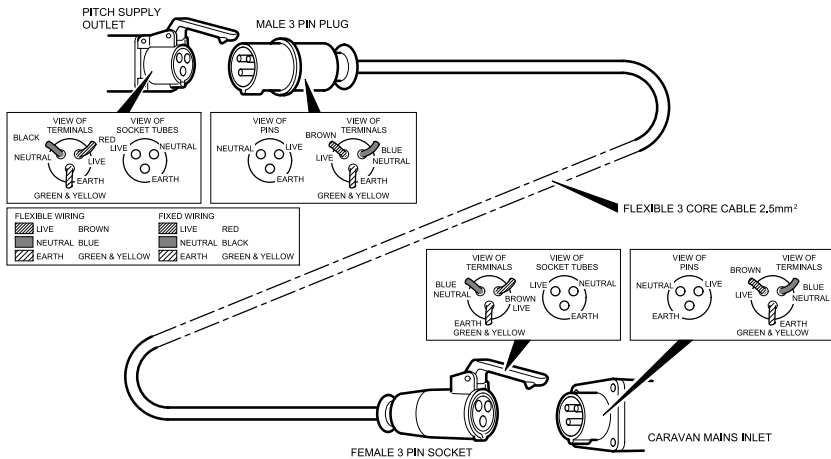

**WARNING:** It is essential that connections are made exactly as shown. If terminal markings are not in accordance with the above diagram they must be ignored.

- (vii) Place any surplus cable under the campervan. Ensure that the surplus cable is not coiled up as it could overheat.
- (viii) The MCB main electricity supply switch should be put in the 'ON' position.
- (ix) Check the RCD is working by pressing the test button. Once pressed all electrical lights and appliances should cease to operate. Reset, and then check the electrical system is operational.
- (x) Finally in order to get your 12V system operational, ensure the master 12V switch is in the 'ON' position.

### DISCONNECTING MAINS SUPPLY WHEN LEAVING SITE

- (i) Switch 'OFF' the RCD in the campervans distribution unit.
- (ii) Remove the male 3 pin plug from the site supply.
- (iii) Disconnect the female 3 pin plug from the campervan and store the cable in an appropriate locker.

### OVERSEAS ELECTRICAL CONNECTION

**Please Note:** Connection to a mains voltage supply OVERSEAS requires particular attention.

Care must be taken when connecting supplies abroad since the supplies can be of REVERSE POLARITY.

The significance of REVERSE POLARITY is that when equipment is switched off, it may not be electrically isolated. The only certain way of making equipment safe is to unplug it.

A means of checking the polarity of the mains supply when overseas is recommended. There are available several proprietary makes of equipment for the purpose.

If it can be achieved, it is preferable to connect live to live and neutral to neutral to maintain full electrical protection.

CHECK all campervan equipment is set-up to accept the site supply before actually switching on.



## **GAS SAFETY ADVICE**

In the event of a suspected gas leak the gas must be turned off using the isolation valve on the LPG tank. A competent gas fitter should then check the system before it is used/reused.

Regularly check flexible gas hose, joints and connections for tightness. Finally, make sure that each gas appliance is working efficiently to the recommendations of the appliance manufacturers.

See Index - Ventilation

## **FACTS ABOUT LPG**

- LPG is not poisonous.
- Bi-products of incomplete combustion are harmful to health.
- LPG is dangerous if all air and oxygen is excluded.
- LPG has been given a smell by the manufacturers in order to identify leaks.
- The gas is heavier than air and therefore sinks to the lowest point.

## **AWNING SPACES, LPG AND APPLIANCE EXHAUST**

Space and Water heaters may produce sufficient amounts of CO<sub>2</sub> to pollute the awning space, if it is totally enclosed and therefore **MUST NOT BE** used on gas when an awning is attached.

**Please note:** Ventilation holes must be clear at all times.

## **LPG GAS SYSTEM**

Erwin Hymer Group UK does not recommend the use of any external cylinders.

Please ensure that you have read the operating instructions for each gas appliance contained in your Owners Information Pack.

## **WARNINGS**

- **Fresh air circulation should be allowed below the campervan when appliances are in use and when flues terminate below the floor to allow free evacuation of the products of combustion. At least three sides of the underfloor space should always be kept open and unobstructed especially by snow. Do not make any additional openings in the floor.**
- **No appliance shall be used outside when connected to an internal outlet.**
- **Maintain adequate spacing of combustible materials from sources of heat or naked flame.**
- **Do not use additional independent gas appliances inside the campervan.**

## GUIDELINES FOR THE SAFE REFUELLING OF AUTOGAS VEHICLES

### Health and Safety of Refuelling

The driver, when pulling up to the Autogas dispenser, is to apply their handbrake and switch off the engine.

No ignition sources should be present including no smoking, no naked flames or mobile phones.

### General Filling Guidelines

This is a guide for filling your LPG tank fitted to your campervan.

**Note:** The vehicle's LPG tank is fitted with an automatic stop fill valve set at 80% of the tanks volume, which should prevent the vehicle from being overfilled. If an overflow does occur, put the nozzle out of action and call an engineer to inspect it. It is recommended that the driver of the vehicle should get their vehicle inspected by a recognised LPG servicer.

The gas system in your campervan has been functionally tested at the factory using gas vapour not LPG. In some instances, this may cause the LED level display to show a false reading. To calibrate the display with the mechanical level switch in the tank, fill the tank with LPG as instructed here.

### Filling Nozzles

There are two types of filling nozzles commonly used

- LG30 Gas Guard™
- V10 DeVisser™

Both types of filling nozzle use the Bayonet type nozzle connection, which should connect directly on to the vehicle filler point.

### Adaptors and Portable LPG Cylinders

Adaptors are not recommended for use at Autogas tanks. Calor also complies with the UKLPG guidance and does not allow the filling of owner used portable refillable LPG cylinders at Autogas refuelling sites. A copy of this guidance can be found on the UKLPG website [www.uklpg.org](http://www.uklpg.org).

**Safety Note:** When filling the vehicle, you must always ensure that the nozzle is correctly fitted and clamped. This should stop any possible product release due to a poor connection seal.

### First Aid

If any product is released and comes into contact with you or the customer the following first aid measures should be used:

**Inhalation:** Remove the affected person to fresh air. Keep the patient warm and at rest. If breathing has stopped administer artificial respiration. Give external cardiac massage if necessary. If the person is breathing, but unconscious, place them in the recovery position. Obtain medical assistance immediately.

**Skin:** Burns should be flushed with tepid water to normalise temperature and until circulation returns. Cover the burns with sterile dressings. Do not apply ointments or powders. Obtain medical assistance immediately.

**Eyes:** Cold burns should be flushed immediately with water at normal temperature. Hold eyelids apart while flushing to rinse entire surface of the eye and lids with water. Cover the eye with a sterile dressing and obtain medical assistance immediately.

### Filling Instructions

Always check that the nozzle is disconnected from the vehicle and replaced in the dispenser holder before the vehicle is driven away.

### Gas Guard™ nozzle filling instructions

#### Connecting

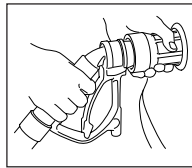

1. Push nozzle over the lugs on the filler valve and turn barrel quarter turn clockwise to lock. Do not squeeze lever before nozzle is connected. From this

moment onwards ensure hands are away from the nozzle.

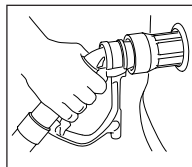

2. Pull back lever and latch into place. Ensure lever is latched securely.

Push the 'FILL' button dispenser and hold until the fill is complete or

desired amount reached.

## Disconnecting

Ensure hands are away from the nozzle barrel.

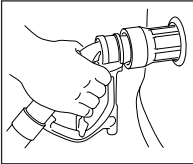

3. When dispensing has ended, squeeze back lever and release the latch, then release the lever fully. A small release of gas will occur as you release the

lever. This is normal! Do not place hands on barrel until after the gas has released.

4. Turn the barrel anti-clockwise a quarter turn to release nozzle from the vehicle. Replace nozzle in holder on dispenser.

## De Visser™ nozzle filling instructions

Ensure De Visser™ nozzles are fitted with protective nozzle shields. Report to site staff if missing.

## Connecting

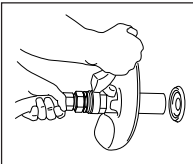

1. Hold the hose behind the nozzle and the guard, keeping lever pushed forward with the handle at the 12 o'clock position.

Locate the nozzle over the lugs on the filler valve and turn the lever quarter turn clockwise to lock.

From this moment ensure hands are away from the nozzle barrel.

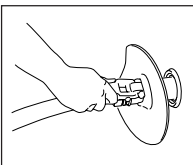

2. Pull back lever towards hose and latch into place. Ensure lever is latched securely. Push button and hold until the fill is completed or desired amount reached.

## Disconnecting

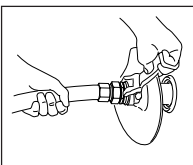

Ensure hands are away from the nozzle barrel.

3. Hold hose behind guard and release lever by pushing forward. (Do not place hands on the nozzle until after the

gas has been released.

A small release of gas will occur as you release the lever. This is normal!

4. Turn lever anti-clockwise quarter turn to release nozzle from vehicle. Replace nozzle in holder on dispenser.

## GAS SUPPLY

Your campervan is designed to operate using either propane or butane liquefied petroleum gas at 30M/bar. Gas can be obtained from a LPG filling station. To locate your nearest station search [www.mylpg.eu](http://www.mylpg.eu)





### Connection

Make sure that heating and cooking appliances and gas tank are switched off.

Each gas appliance is connected to its own gas isolation valve. These are identified on the tap via a label. Below is a key to identify each label.

To operate the tap the arrow on the tap shows the direction of flow for the gas.

There will be a small label next to the bank of taps, which is also reproduced below.

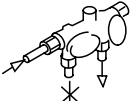
|   |  |
|---|--|
|  <p>Water Heater</p> |  <p>Cooking Appliance</p> |
|  <p>Space Heater</p> |  <p>Hob</p>               |
|  <p>Refrigerator</p> |  <p>Gas On/Off</p>       |

## Gas Regulator

Your new campervan has been fitted with a fully approved gas regulator designed to operate with Propane gas at a pressure of 30mBar. Your regulator is fitted with a test point, which is accessed via the inlet at the side of the regulator. This access point is only for carrying out gas pressure tests and **must not** be used for any other purpose.

**Please note:** Only Gas Safe Register™ or STGW approved gas fitters can carry out any work on your campervan gas installation.

This regulator is not designed for use when vehicle is in motion.

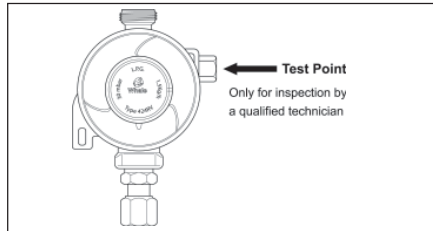

## Gas Operation

In order to make all your campervan gas appliances operational it is necessary to open each appliance gas tap as detailed on the previous page. All your gas appliances should now be operational. Instructions on how to use each appliance are detailed later in your handbook.

**WARNING: Aerosols and highly flammable liquids must not be stored in the compartment behind, or adjacent to, any gas appliance. Some industrial LPG appliances operate at high pressure and require a 'high pressure' regulator. This often has an adjusting handle on it. NEVER use such a regulator on a campervan.**

**Ventilation holes must be clear at all times.**

## WATER SYSTEM

### Filling your fresh water tank

Your campervan is fitted with a standard water inlet which can be filled using a hose pipe connected to a tap placed into the water filler point.

Please take care not to over fill your tank it is advised that someone monitors the water level in the tank while filling is in progress.

### Waste Water Tank

Your new campervan is also fitted with a 45 litre waste water tank. All waste water excluding the toilet waste will run into the waste water tank. The level of water in the tank can be monitored using the control panel. Opening the grey waste outlet provided on the outside of the campervan empties the tank. Open the tap when the outlet is over a drain and the water will run out of the tank.

### Draining Down Your Water System

- (i) It is essential that you drain down your campervan water system when it is not in use. This is most important during winter months to protect against frost damage
- (ii) Disconnect the water pump and switch off power supply.
- (iii) Open the safety drain valve on the water heater located next to the water heater.
- (iv) Open all taps and remove all plugs from sinks and showers. Lever operated taps should have the lever put into the up and central position.
- (v) Open both the blue and grey drain outlets on the outside of your campervan.
- (vi) Adjust the level of the campervan to ensure that the drain outlet is at the lowest point of the campervan.



## ELECTRICAL SYSTEM 12V POWER SUPPLY

### Battery Installation

Your campervan will be fitted with a charging and power distribution unit.

When installing the leisure battery please ensure that it is placed on the battery tray supplied with your campervan. Then place the tray in the battery locker fitted. Connect the battery to the clamp fittings connected to the connection leads within the battery box.

Firmly attach the vent pipe to the battery and ensure that the pipe exits the vehicle in the hole provided in the bottom of the battery compartment.

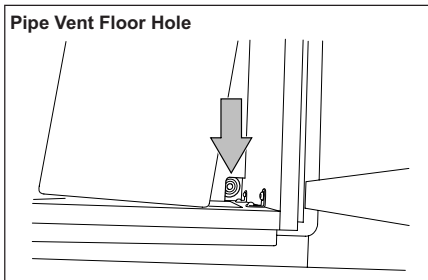
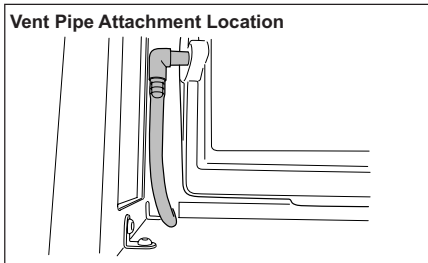

We recommend that you refer to the NCC approved battery scheme, which can be found at [www.thencc.org.uk](http://www.thencc.org.uk).

### Battery Maintenance

#### Storage

Ensure that the leisure battery is fully charged before placing the vehicle into storage.

Check the battery state every month, if the terminal voltage drops below 12.07V then re-charging is necessary.

Charging should be carried out in a cool, dry well ventilated area.

**CAUTION:** Do not place the battery onto cold surfaces such as concrete as this will affect the battery's ability to charge.

#### Points to remember

- Prolonged discharge causes harmful sulfation and may damage a battery.
- For peak performance never let a battery sit discharged for long periods of time.
- Over discharged batteries are permanently damaged and need to be replaced.

**Note:** Do not over discharge the battery. One of the most common causes of battery failure is when the battery is discharged below the recommended level of approximately 12.2v - ref table. Discharging a battery below this figure will cause permanent damage.

Overheating and gassing will occur when re-connected to the mains supply.

|         | 12 Volt Battery | State of Charge |
|---------|-----------------|-----------------|
| Good    | 12.7V           | 100%            |
|         | 12.5V           | 90%             |
| OK      | 12.42V          | 80%             |
|         | 12.32V          | 70%             |
|         | 12.20V          | 60%             |
|         | 12.06V          | 50%             |
| Warning | 11.9V           | 40%             |
|         | 11.75V          | 30%             |
|         | 11.58V          | 20%             |
| Damaged | 11.31V          | 10%             |
|         | 10.5V           | 0%              |

**Good:** the battery is in good condition and not in need of charging

**OK:** nothing to worry about but put the battery on charge as soon as you can

**Warning:** get the battery on charge as soon as you can. Leave it and the battery will be damaged, possibly beyond repair

**Damaged:** Replace battery

## Generators / Charger

All electrical equipment fitted in your new campervan can be run from either a controlled generator or charger whose output is maintained between 11volts and 14volts.

At least once every 3 years, the campervan electrical installation should be inspected and tested and a report on its condition obtained, as prescribed in British Standard BS7671.

## 230v POWER SUPPLY

### Mains Unit

The Mains Unit replaces the conventional fuse box. Similar, but larger ones are often fitted in new houses. The unit, normally located on the front bed box, gives overloads and earth leakage protection for the 230V electrical supply in your campervan.

For normal operation all switches on the unit need to be in the ON position. The switches on the left of the unit are known as MCB's (miniature circuit breakers). These take the place of the conventional fuse but are more convenient. In the event of a fault the MCB 'trips' i.e. automatically moves to the OFF position. After elimination of the fault the MCB can be re-set by switching to the ON position (against the spring pressure in an upwards direction). If an earth fault develops, or a person was to touch a live piece of equipment, the leakage of current to earth should immediately operate the RCD (residual current device) and 'trip' the main switch, to the OFF position. This switch can only be re-set after elimination of the fault.

**Please note:** In case of difficulty, consult an approved electrical installation contractor (who may be the local electricity board). It is dangerous to attempt modifications and additions yourself.

**CAUTION:** Lamp holder-plugs (bayonet- cap adaptors) should not be used under any circumstances.

### Resetting the RCD

To re-set, operate the switch as for MCB's. Periodically, the RCD should be checked by operating the test button marked 'T'. The unit should immediately switch to the OFF position. If the unit does not switch off then a qualified electrician should be consulted. If the unit does switch off, the test is complete and the switch can be re-set restoring the supply back to normal.

**Please note:** Simultaneous operation of all of the 230V mains electrical equipment may not be possible. A typical UK site mains hook-up point provides a maximum output of 16 amps and on some continental sites the available output may be as low as 5 amps. If your loading exceeds the site supply it may trip the site circuit breaker. Please check the available mains output with your site operator. The following items need to be added together if used simultaneously.

230V mains equipment typical consumption figures:

- Charger ..... 2.2 amps
- Water heater ..... 3.9 amps
- Blown air heaters ..... 8.5 amps
- Colour TV ..... 3.33 amps

### AUTOMATIC CHARGING SYSTEM

The battery charger will operate automatically when the campervan is connected to the mains outlet on a campervan site.

**Note:** The charging unit only charges the leisure battery not the vehicle battery.

When the campervan engine is running the 12V system will not operate with the exception of the 12V refrigerator.



## SCHAUDT WA 121525 BOOSTER UNIT

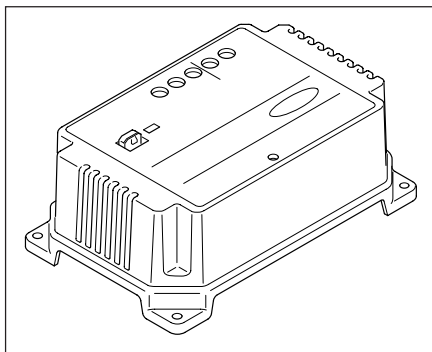

### General

Your vehicle may be fitted with a Schaudt booster unit which is only required if the base vehicle is fitted with a smart alternator.

The unit does not require any interaction from the end user or require any maintenance and will simply function as its intended, during the normal operation of the vehicle.

### Function

The WA 121525 Booster is used for the optimum charging of leisure batteries such as lead-acid, led-gel, AGM.

The main purpose of the booster is to ensure the leisure battery remains charged whilst the vehicle is in motion.

Your vehicle may be fitted with a smart energy saving alternator, this is engine/base vehicle dependant. The charge voltage for these alternators varies greatly depending on the driving state. Without a booster fitted, the vehicle leisure batteries are at risk of discharge whilst the vehicle is in motion.

### Location

The location of the booster will vary depending on each vehicle layout, but will always be located within 1m of the vehicle's power distribution unit.

Please contact Erwin Hymer Group UK Ltd if any further information is required regarding this product.

CHECK all campervan equipment is set-up to accept the site supply before actually switching on.

### Internal Lighting

Your new campervan is fitted with all LED lighting.

### MAXIMUM POWER RATINGS FOR INTERNAL LIGHTS

| Type of Light        | Maximum Bulb Rating |
|----------------------|---------------------|
| Downlighters .....   | 1.2 watts           |
| Reading lights ..... | 1.2 watts           |
| Awning lights .....  | 4 watts             |

LED tape is used as backlit mood lighting. The wattage varies from 4.8 to 9.6W depending on the location within the vehicle.

**Note:** All LED lights can only be replaced with a new complete unit and not a replacement bulb.

**CAUTION:** It is recommended to set the position of the reading light before switching on. Do not look directly at LED lights.

**MAINS UNIT - CAMPERVAN**

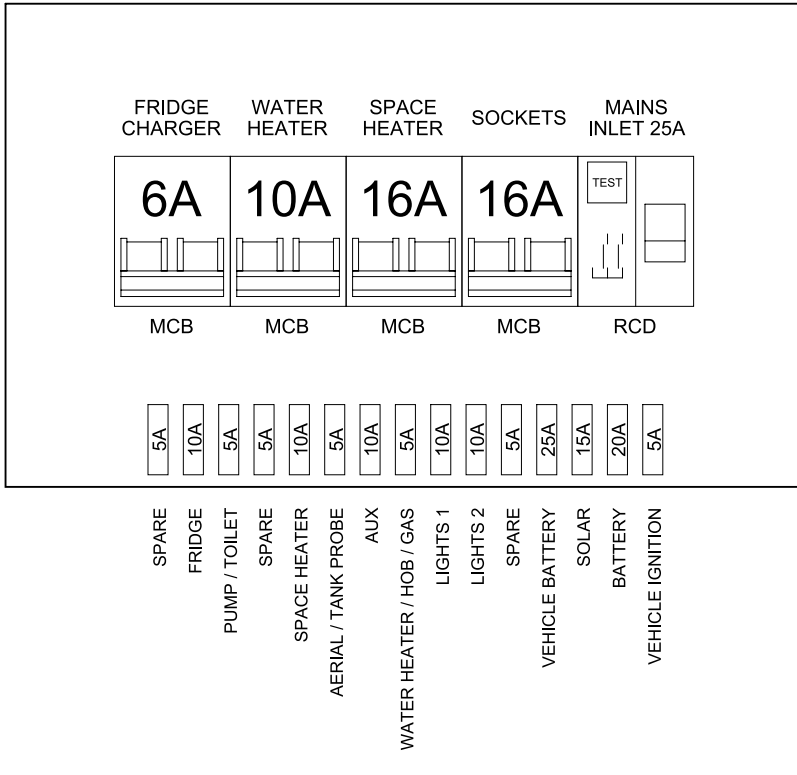

**MAINS UNIT - CAMPERVAN POP TOP**

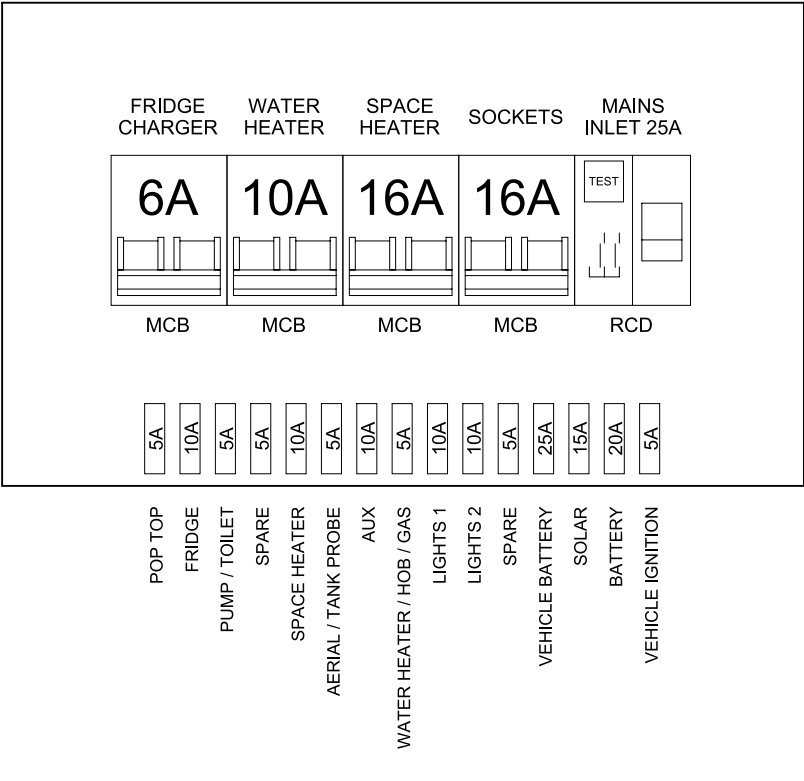



## **HOW TO USE YOUR CAMPERVAN'S EQUIPMENT**

Within this section of your campervans handbook we will give you brief details on how to operate all of the campervans equipment from the gas cooking equipment to the window blinds. For further details on the major equipment within your campervan please read the individual appliance instructions contained with your user information pack.

For vehicles fitted with a pop-top roof, please refer to accompanying user guide.

**Please note:** Before attempting to use any gas equipment please ensure that the LPG tank contains gas and the valve is in the on position. Also ensure the appliance isolation valves are in the on position.

**Please note:** Before attempting to use any electrical appliance please ensure that you have connected the mains connection cable to a mains hook up and that the mains isolation switch is in the on position. Ensure the 12V master switch is in the ON position. This is found in the side of the unit next to the entrance door.

# HOW TO USE YOUR CAMPERVAN'S EQUIPMENT

## CONTROL PANEL

Your new campervan is fitted with the control panel shown below.

### Vegas Button Control Panel

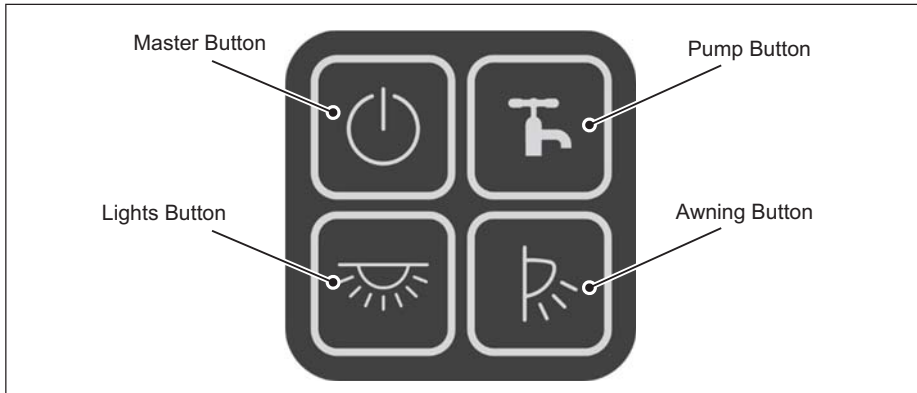

#### Master Button

When the Master Button is pressed, the control panel will switch power to all non-essential accessories.

- Some features, such as lights, will need the Master Button to be switched on to work.

#### Lights Button

When the Lights Button is pressed, the control panel will switch power to all the interior lights.

- If the Master Button is switched off then this button will not function.

#### Pump Button

When the Pump Button is pressed, the control panel will switch power to the water pumps.

- Holding down the Pump Button forces the internal pump to run regardless of tank level. This is so that the user can purge their water pipes.

#### Awning Button

When the Awning Button is pressed the control panel will switch power to the exterior awning light.

#### Display Indicator

The Display indicator on the Vegas Voltmeter Panel is used to display the Leisure Battery voltage and the Water level, depending on which button is pressed.

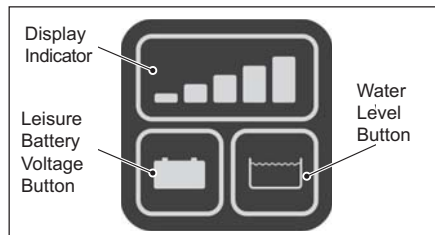

- If a waste tank is fitted, the lowest indicator will illuminate when the waste tank is full.
- When the pump is running the 5th indicator (Green) will illuminate to indicate that the pump is currently running.

#### Leisure Battery Voltage Button

When the Leisure Battery Voltage Button is pressed, the Display Indicator will light up and display the voltage level of the Leisure Battery.

#### Water Level Button

When the Water Level Button is pressed, the Display Indicator will light up and display the water level reading inside the water tank.

**Note:** The water level reading should be used as a guide only and there is a degree of tolerance depending on water type and temperature.

# HOW TO USE YOUR CAMPERVAN'S EQUIPMENT

## Water Level Calibration

Before the Water Level Button is used for the first time, you will need to calibrate the Control Panel to your water tank.

- Make sure your water tank is at the recommended maximum level before starting the calibration process.
- You will need to re-calibrate the Control Panel if you change water tank.

Use the following steps to calibrate your Control Panel.

1. Hold down both the Voltage Button and Water Level Button for 6 to 8 seconds to get into calibration mode.
2. When you are in calibration mode, the Display Indicator will light up depending on which water probe you have installed.
  3. To cancel calibration mode, press and hold Leisure Battery Voltage Button for two seconds.
  4. To start the calibration process, press and hold the Water Level Button for two seconds.
  5. If the calibration process was successful, the display will flash three times.
    - If the calibration process is successful, the Control Panel will restart and be ready to use.
  6. If the calibration process was unsuccessful, the display will flash two times.
    - If the calibration process fails, go back to step 2 to start the calibration process again.

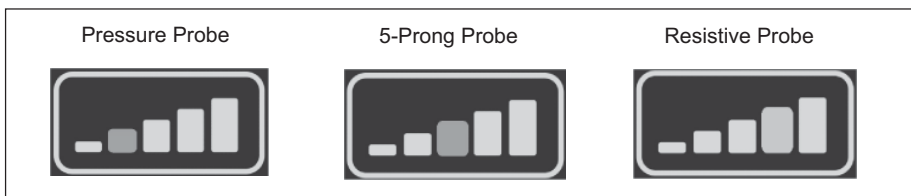

## Vegas Voltmeter without Water or Gas Level

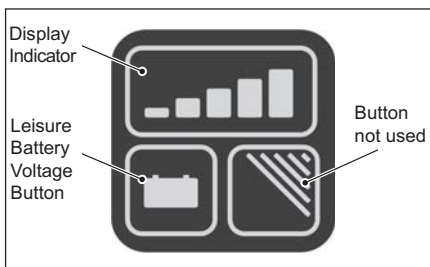

### Display Indicator

The Display indicator on the Vegas Voltmeter Panel is used to display the Leisure Battery voltage.

If a waste tank is fitted, the lowest indicator will illuminate when the waste tank is full.

### Leisure Battery Voltage Button

When the Leisure Battery Voltage Button is pressed, the Display Indicator will light up and display the voltage level of the Leisure Battery. The button on the right of the panel is not used on this panel.

# HOW TO USE YOUR CAMPERVAN'S EQUIPMENT

## Whale Heat Control

### Instructions for Use



| Icon | Description   |
|------|---|
|      | Gas heating button                                  |
|      | Gas heating standby indicator                       |
|      | Gas heating on                                      |
|      | Frost protection mode (approx 5°C)                  |
|      | Night time mode (approx 16°C)                       |
|      | Increase temperature button                         |
|      | Decrease temperature button                         |
|      | Lockout indicator                                   |
|      | Electric heating button                             |
|      | Electric heating standby indicator                  |
|      | 0.75kW electric                                     |
|      | 1.50kW electric                                     |
|      | 3.00kW electric                                     |
|      | External control from alternative source available* |
|      | External control from alternative source active*    |
|      | Reset button  |

\*Not available on all models. External control will allow control of the heater via an alternative source.

Please refer to your vehicle handbook for more information.



# HOW TO USE YOUR CAMPERVAN'S EQUIPMENT

## 1. Select Temperature

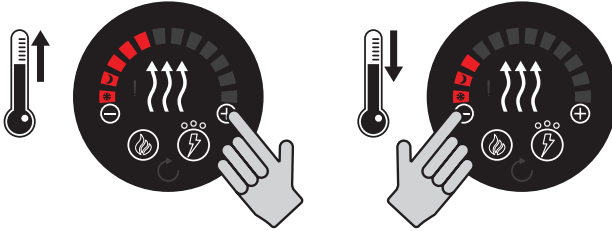

## 2. Activate Gas Power

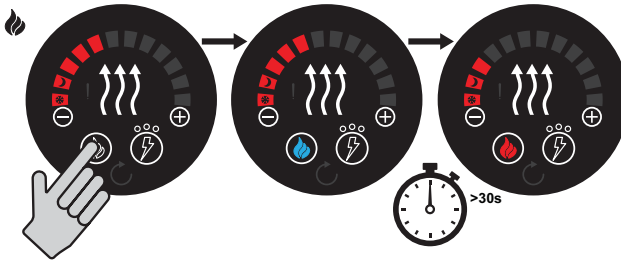

And/Or



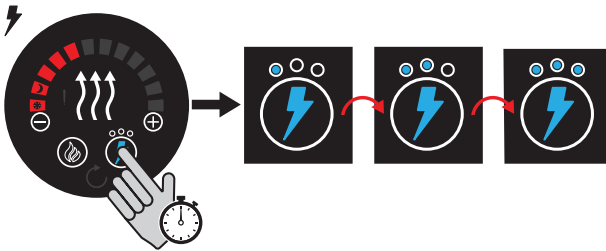

## 3a. Select Electric Setting

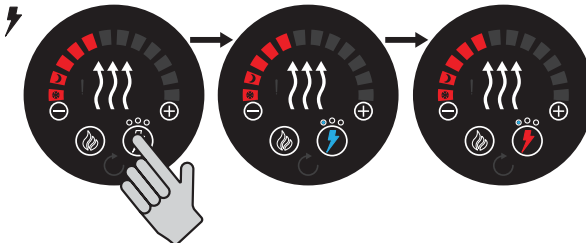



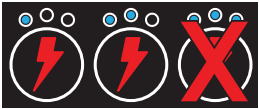

## 3b. Activate Electric Power



# HOW TO USE YOUR CAMPERVAN'S EQUIPMENT

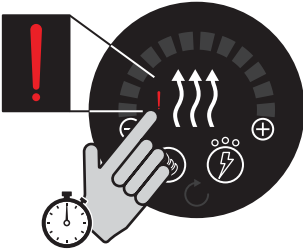



| Usable Electric Settings   |   |   |
|----------------------------|---|---|
| 6A<br>0.75kW<br>230V a.c.  |  |  |
| 10A<br>1.50kW<br>230V a.c. |  |  |
| 16A<br>3.00kW<br>230V a.c. |  |  |

## Troubleshooting - Whale Heat Control

| Step 1 - Show Lockout  |   |
|--|---|
|         |   |
| Step 2 - Identify Lockout  | Step 3 - Recommended Action   |
| 1<br> | <b>Inadequate gas supply</b> <ol style="list-style-type: none"> <li>1. Check gas</li> <li>2. 30mbar LPG</li> <li>3. Go to step 4</li> </ol>   |
| 2<br> | <b>Overheat</b> <ol style="list-style-type: none"> <li>1. Check air vents and ducts are not restricted</li> <li>2. Wait 10 mins for heater to cool down</li> <li>3. Go to step 4</li> </ol> |
| 3<br> | <b>Inadequate supply voltage</b><br>10.5 - 15.9V d.c. Heater inoperable under 10.1V<br>≥10.5 / ≤15.9V d.c. ✓<br><10.5 / >15.9V d.c. X<br>Go to step 4                                       |

# HOW TO USE YOUR CAMPERVAN'S EQUIPMENT

## Troubleshooting - Whale Heat Control (continued)

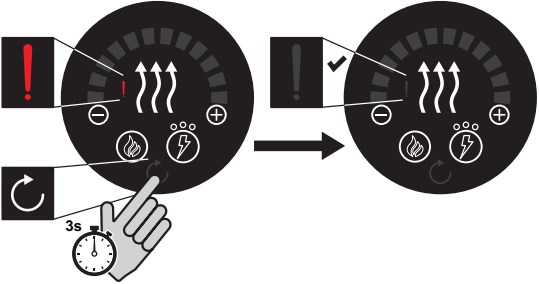
| Step 2 - Identify Lockout  | Step 3 - Recommended Action   |
|--|---|
| <p>4</p>  | <p><b>Flue blockage</b></p> <ol style="list-style-type: none"> <li>1. Check flues for blockages</li> <li>2. Go to step 4</li> </ol>   |
| <p>5</p>  | <p><b>Internal fault</b></p> <ol style="list-style-type: none"> <li>1. Call Whale support +44 (0)345 9090 911<br/>For Europe, please see enclosed Webasto-Service information.</li> <li>2. Go to step 4.</li> </ol> |
| <p>6</p>  | <p><b>Control panel fault</b></p> <ol style="list-style-type: none"> <li>1. Power off</li> <li>2. Power on</li> </ol>   |
| <p>7</p>  | <p><b>Multiple faults</b></p> <ol style="list-style-type: none"> <li>1. Power off</li> <li>2. Check heater for recurring faults</li> <li>3. Power on</li> <li>4. Go to step 4.</li> </ol>                           |
| <p><b>Step 4 - Clear Lockout</b></p>   |   |
|          |   |

If problems persist, please contact Whale Support on +44 (0)345 9090 911. For Europe, please see enclosed Webasto-Service Information.

# HOW TO USE YOUR CAMPERVAN'S EQUIPMENT

---

## **Maintenance / Repairs**

The vehicle owner must arrange for the appliance to be serviced at least every 2 years from date of purchase, including its gas supply and ducting for the products of combustion (BS EN 624).

All maintenance and repairs must be carried out by a registered gas engineer at a Whale Approved Service Centre or by a member of the Whale Service Engineer Network.

For installation or service information, contact Whale Support.

Tel: +44 (0)345 9090 911

Email: [Info@whalepumps.com](mailto:Info@whalepumps.com)

For Europe, please see enclosed Webasto-Service information.

Guarantee claims, warranty claims and acceptance of liability will be ruled out in the event of the following:

- Modifications to the appliance (including accessories)
- Modifications to the exhaust duct or combustion intake
- Use of replacement and accessory parts other than original Whale parts
- Failure to follow the installation and operating instructions
- Use of the appliance for non-leisure purposes

The heat exchanger **must be** replaced with a Whale original spare part every 10 years from date of registration. See the data label on the heater for the first time it was put into service.

## **Disposal**

This product must be disposed of in accordance with the regulations of the respective country in which it is used. National regulations and laws must be observed.









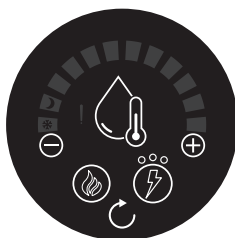







**Please note:** The appliance **must be** installed and serviced in accordance with any relevant regulations in the country where the appliance is installed.

If the electrical supply cord is damaged, it must be replaced by the manufacturer, its service agents or similarly qualified persons in order to avoid a hazard (BS EN 60335-1).

# HOW TO USE YOUR CAMPERVAN'S EQUIPMENT

## Whale Heat Control Panel Operation



| Icon  | Description   |
|---|---|
|    | Gas heating button                                  |
|    | Gas heating standby indicator                       |
|    | Gas heating on                                      |
|    | Frost protection mode                               |
|    | Eco mode  |
|    | Increase temperature button                         |
|    | Decrease temperature button                         |
|    | Lockout indicator                                   |
|   | Electric heating button                             |
|  | Electric heating standby indicator                  |
|  | 0.38kW electric                                     |
|  | 0.75kW electric                                     |
|  | 1.50kW electric                                     |
|  | External control from alternative source available* |
|  | External control from alternative source active*    |
|  | Reset button  |

\*Not available on all models. External control will allow control of the heater via an alternative source.

Please refer to your vehicle handbook for more information.

# HOW TO USE YOUR CAMPERVAN'S EQUIPMENT

## Select Temperature

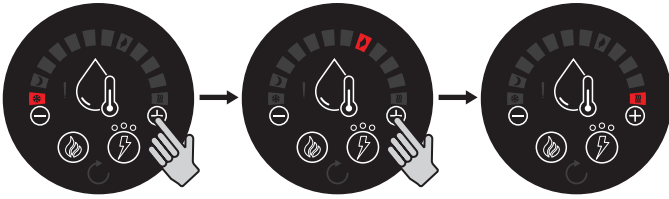

## Activate Gas Power

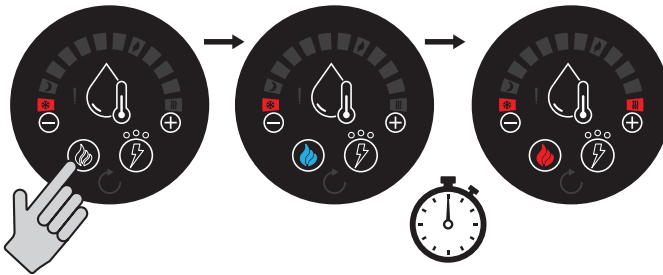

## Activate Electric Power

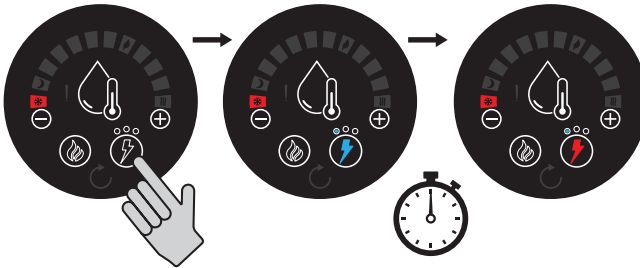

## Select Electric Setting

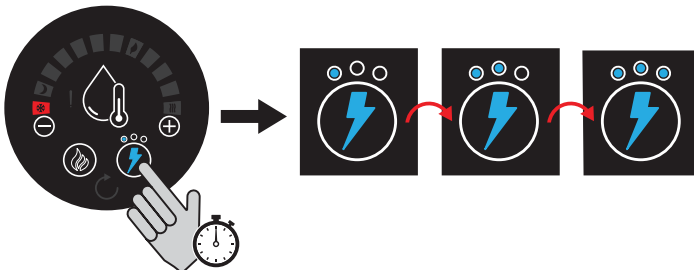





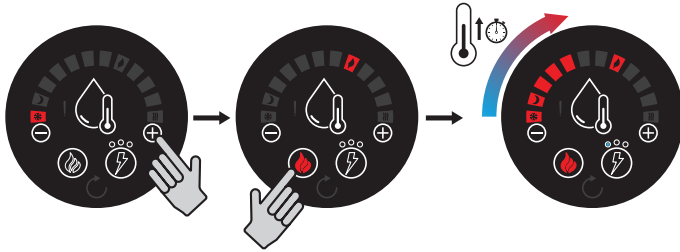

# HOW TO USE YOUR CAMPERVAN'S EQUIPMENT

## Water Temperature Display



\*Not available on all models. Electric settings only available on Gas & Electric Heat Control Panel models.







| Usable Electric Settings    |   |   |
|-----------------------------|---|---|
| 1.6A<br>0.4kW<br>230V a.c.  |  |  |
| 3.3A<br>0.75kW<br>230V a.c. |  |  |
| 6.5A<br>1.50kW<br>230V a.c. |  |  |

## Electric Power Management

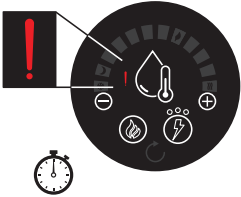
For dual Heat Control Panel variants, when selecting a high electric setting on the space or water heater, the control panel may automatically step down the other Heat Control Panel to a lower electric setting or turn off if at risk of exceeding 16A. The last heater selected has AC mains priority.

# HOW TO USE YOUR CAMPERVAN'S EQUIPMENT

## Troubleshooting - Whale Heat Control Panel

| Step 1 - Show Lockout   |   |
|---|---|
|  |   |
| Step 2 - Identify Lockout   | Step 3 - Recommended Action   |
| 1   |  <p><b>Fault type #1 - Inadequate gas supply</b></p> <ol style="list-style-type: none"> <li>1. Check gas</li> <li>2. Temp &lt;5°C, use Propane rather than Butane</li> <li>3. Check flue for blockages</li> <li>4. Go to step 4</li> </ol>   |
| 2-3   |  <p><b>Fault type #2-3 - Overheat Fault</b></p> <ol style="list-style-type: none"> <li>1. Check heater is completely full of water</li> <li>2. Run pump with one hot tap open until water flows smoothly</li> <li>3. Go to step 4</li> </ol> |
| 4   |  <p><b>Fault type #4 - Low Voltage Fault</b></p> <p>10.5 - 15.9V d.c. Heater inoperable under 10.1V<br/>         ≥10.5 / ≤15.9V d.c. ✓<br/>         &lt;10.5 / &gt;15.9V d.c. X</p> <p>Go to step 4</p>                                      |
| 5   |  <p><b>Fault type #5 - Air Pressure Fault</b></p> <ol style="list-style-type: none"> <li>1. Check flues for blockages</li> <li>2. Go to step 4</li> </ol>  |
| 6-11  |  <p><b>Fault type #6-11 - Internal Fault</b></p> <ol style="list-style-type: none"> <li>3. Go to step 4</li> <li>4. Call Whale Support +44 (0)345 9090 911</li> </ol>  |
| 12  |  <p><b>Fault type #12</b></p> <ol style="list-style-type: none"> <li>1. Power off</li> <li>2. Check Heater for recurring faults</li> <li>3. Power On</li> <li>4. Go to step 4</li> </ol>   |



# HOW TO USE YOUR CAMPERVAN'S EQUIPMENT

## Step 4 - Clear Lockout

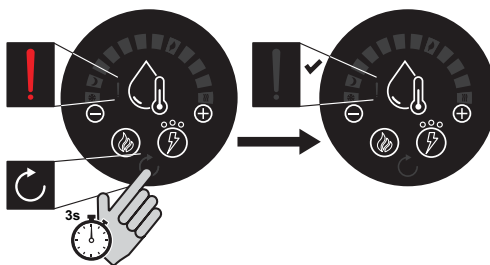

If problems persist, please contact Whale Support on +44 (0)345 9090 911. For Europe, please see enclosed Webasto-Service Information.

### **Maintenance / Repairs**

To clean and sterilise inside the Water Heater use diluted sterilising fluid and fully rinse through with clean water afterwards. The outside of the appliance should not normally require cleaning. If it does, isolate the electrical supplies and wipe down with a soft, damp cloth only. Do not use abrasive cleaners. Allow to fully dry before reconnecting the electrical supplies. If de-scaling of this appliance is required, this can be done using a domestic liquid de-scaling product and fully rinse through with clean water afterwards. Cleaning and user maintenance must not be carried out by children without supervision.

The Whale Water Heater **must be** checked periodically by a Whale Approved Service Centre/Technician, or competent person, at least annually. This **must be** completed according to the practice in the country where it is used and according to the Whale instructions. Whale recommends annual testing of gas soundness and combustion by an accredited LPG engineer. The appliance contains ESD sensitive components and therefore **must only** be opened by a Whale Approved Service Centre/Technician. To contact Whale support telephone: +44 (0)345 9090 911.

# HOW TO USE YOUR CAMPERVAN'S EQUIPMENT

## Operating Instructions - Drain Valve

The Water Heater must be drained before travelling or if it is not being used for a period of more than 3 days, or if there is a danger of freezing (unless Frost Protection setting is active). Check the heater has fully drained if there is a risk of freezing. The drain valve is located at the top of the water heater, beside the cold and hot water inlet. To operate the drain valve, turn the yellow lever clockwise 90 degrees.

If the plumbing system in the vehicle causes air locking preventing the water heater from draining, consideration should be given to fitting a vacuum relief valve, Whale Part # AK1228.

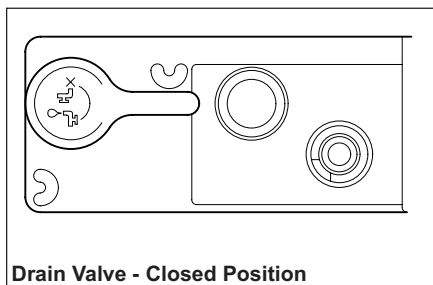

**Drain Valve - Closed Position**

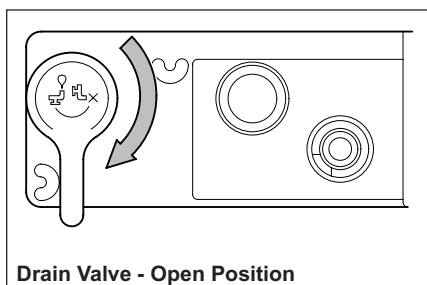

**Drain Valve - Open Position**

## Winterising

If the Water Heater is not going to be used for more than 3 days, disable the Water Heater on the control panel, isolate the gas supply by ensuring the gas shut off valve to the Water Heater is closed and that the gas supply is turned off (if no other gas appliances require a continued supply). The Water Heater must be fully drained to avoid risk of freezing.

**General Safety Note:** The operating pressure of the gas supply to the Water Heater must be either 28-30mBar Butane or Propane.

## Maintenance

To clean and sterilise inside the Water Heater use diluted sterilising fluid and fully rinse through with clean water afterwards. The outside of the appliance should not normally require cleaning. If it does, isolate the electrical supplies and wipe down with a soft, damp cloth only. Do not use abrasive cleaners. Allow to fully dry before reconnecting the electrical supplies. If descaling of this appliance is required, this can be done using a domestic liquid descaling product and fully rinse through with clean water afterwards. Cleaning and user maintenance must not be carried out by children without supervision.

**Please Note:** Water will drip from the discharge pipe of the pressure-relief valve during heating up. The pressure relief valve must be operated regularly (at least twice a year) by turning the yellow lever in the anti-clockwise direction, to remove lime deposits and to ensure that it is not blocked.

The Whale Heater must be checked periodically by a Whale Approved Service Centre/Technician, or a competent person, at least annually. This must be completed according to the practice in the country where it is used and according to the Whale instructions. Whale recommends annual testing of gas soundness and combustion by an accredited LPG engineer. The appliance contains ESD sensitive components and therefore must only be opened by a Whale Approved Service Centre/Technician.

# HOW TO USE YOUR CAMPERVAN'S EQUIPMENT

## OVEN

### Safety

- This appliance may be used by children aged 8 years or older and persons with reduced physical, sensory or mental capabilities and/or lack of experience and knowledge only if they are supervised or have been given instructions on the safe use of this appliance and understand the potential hazards.
- Keep children younger than 8 years away from the appliance, except under constant supervision.
- Do not allow children to play with the appliance.
- Do not allow children to clean or maintain this equipment unattended.
- Use only parts supplied by the manufacturer.
- Do not change or adjust anything on the appliance, unless the change is authorised by the manufacturer or its representative.
- If the power cord is damaged, it must be replaced by the manufacturer, its service agent or similarly qualified persons in order to avoid a hazard.
- Use the appliance for cooking only and not for anything else, for example room heating. This can lead to carbon monoxide poisoning and overheating. The manufacturer cannot be held liable for damage resulting from improper use or incorrect setting of the controls.
- This appliance is not intended to be operated by means of an external timer or separate remote-control system.
- The use of this gas cooking appliance results in the production of heat, moisture and products of combustion in the room in which it is installed. Ensure the room has sufficient ventilation when the appliance is in use. During prolonged use, additional ventilation may be needed by opening a window or increasing the extraction force of the hood.
- Never extinguish a cooking fire with water. Turn the burner off and cover the flame with a lid or a fire blanket.
- The appliance and its accessible parts become hot during use. Care should be taken to avoid touching heating elements.
- The cooking process must be supervised. A short term cooking process must be supervised continuously. Unattended cooking on a hob with fat or oil can result in fire. Do not leave the appliance unattended when in use.
- The use of inappropriate hob guards can cause accidents.
- Danger of fire, do not store items on the cooking surface of the hob.
- The burners and pan supports are hot during and after use. Allow all parts to cool before touching them, as this can cause serious injury.
- The food shelves and trays in the appliance are hot during and after use. Allow all parts to cool before touching them, as this can cause serious injury. Always use oven gloves when removing the shelves and trays.
- Do not store items in the appliance.
- Do not put heavy objects on the open appliance door.
- The appliance and accessible parts become hot when the grill is in use. Young children should be kept away.
- CAUTION: hot surfaces. Door must be open when grill is in use.

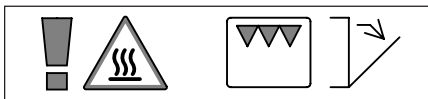

- In the event that abnormal drift in cooking temperature of the oven is observed, have the thermostat checked by a qualified service engineer.
- Care should be taken not to overload the oven, allowing adequate spacing to ensure free circulation of heat.
- Do not use steam cleaners or pressure washers to clean the appliance. See Maintenance and cleaning for instructions.

# HOW TO USE YOUR CAMPERVAN'S EQUIPMENT

---

- **Do not allow oil or fat to build up on the appliance. Clean the appliance after each use.**
- **Before cleaning or maintenance work, the appliance must be left to cool and be disconnected from the gas and electrical supplies.**
- **The glass lid may snap shut towards the end of lowering due to the travel-lock action of the hinges. Make sure all fingers are clear of the appliance when closing the lid.**
- **Do not use harsh abrasive cleaners or sharp metal scrapers to clean the surface of the glass, since they can scratch the glass surface which may result in shattering of the glass.**
- **Remove any spillage from the glass lid before opening the lid.**
- **Do not shut the glass lid when the burners are lit or still warm.**



## Before use

Before using the appliance:

- Ensure that all packaging materials have been removed.
- Clean the appliance with warm water and household detergent and dry carefully with a soft cloth.
- Ensure that the gas supply is connected and turned on.
- Ensure that the appliance is connected to the 12V DC battery for the spark ignition.
- Ensure that the pan supports are positioned properly.
- Ignite the gas burners and let them burn to expel odours and vapours first.
- Ignite the burner and heat the grill for about 20 minutes to eliminate any residual factory lubricants that might impart unpleasant smells to the food being cooked. Smoke may occur during this procedure. Open any windows and turn on mechanical ventilators to help remove the smoke.

- Ignite the burner and heat the oven for about 30 minutes at 200°C to eliminate any residual factory lubricants that might impart unpleasant smells to cooked food. Smoke may occur during this procedure. Open any windows and turn on mechanical ventilators to help remove the smoke.

## Dual Fuel only:

- Ensure the electricity is connected and switched on.
- Prime the hotplate by switching on the hotplate for a short period, without a pan, to harden and burn off the coating. Use a medium to high setting for 3-5 minutes. Allow adequate ventilation to disperse any smoke that occurs during this process. Allow the hotplate to cool.
- Season the hotplate by heating the hotplate for 30 seconds on a medium setting and then switching off. Pour a minimal amount of unsalted vegetable oil onto a clean dry cloth or paper towel and apply a thin coat of oil to the hotplate surface. Wipe off any excess oil, then heat the hotplate on a medium setting for 1 minute. Occasional seasoning will help to maintain the hotplate's appearance.

Only use LPG (Liquefied Petroleum Gas). The appliance operates on propane or butane. Propane is preferred over butane, because butane provides poor performance at an ambient temperature below 10°C and cannot be used at an ambient temperature below 5°C.



# HOW TO USE YOUR CAMPERVAN'S EQUIPMENT

## Maintenance and cleaning

Thetford recommends an annual inspection service by an approved service centre.

Between annual servicing, clean the appliance regularly after use. Before any cleaning work is started, the appliance should have been left to cool and be disconnected from the gas and/or electrical supplies.

- Always remove any spills or contamination immediately after use with soap and hot water. Towel dry the surface with a soft cloth.
- Use a non-abrasive multi-purpose cream cleaner and a nylon scourer pad to clean more stubborn dirt or grease.
- Use a proprietary stainless steel cleaner or polish to remove superficial surface scratching.
- Do not use abrasive cleaners, metal scouring pads or hard brushes. They could damage the appliance.
- If you clean the burner rings, ensure that the holes are not clogged.
- Do not use harsh abrasive cleaners or sharp metal scrapers to clean the glass surface, since they can scratch the glass surface which may result in shattering of the glass.
- Do not leave wet cloths, cleaning pads, residues of food or cleaning products or other dirt to dry on the surface. It can cause pitting, marking or even rusting.
- Always clean in the direction of the brushed finish and not across the grain.
- Cleaning agents containing bleach should not be left in contact with stainless steel.
- Mineral content in water (such as iron or limescale) can affect the appearance of the metal.
- Remove any spillage from the glass lid before opening the lid.
- The control knobs can be removed for cleaning. The knobs are easy to replace.

## Troubleshooting

| Problem                              | Possible cause   | Solution  |
|--------------------------------------|--|---|
| Burners do not burn or burn unevenly | Gas bottle is empty<br>Gas tap is closed<br>Burner caps are not correctly positioned<br>Burners are wet or clogged | Change gas bottle<br>Open tap<br>Allow caps to cool, then reposition them<br>Dry or clean burners |
| Spark ignition does not spark        | 12V DC battery is discharged<br>Connections are loose<br>Ignition points are wet or dirty                          | Charge battery<br>Secure connections<br>Dry or clean ignition points                              |
| Control knobs do not function        | Knobs are mounted incorrectly  | Install knobs correctly   |

If you cannot solve a problem, contact the authorised local Service Centre or Thetford Customer Service in your country.

# HOW TO USE YOUR CAMPERVAN'S EQUIPMENT

## Triplex

### Main components

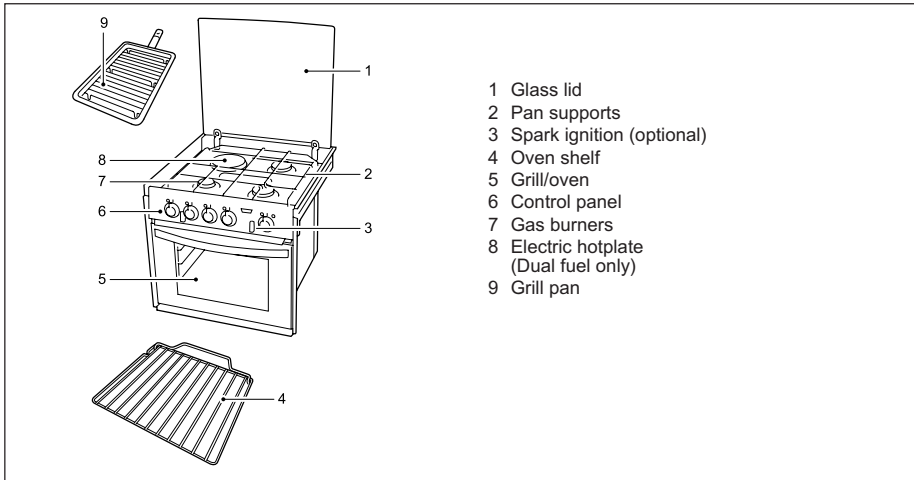

The types of burners may vary depending on the type of appliance. Refer to Technical specifications for further details.

# HOW TO USE YOUR CAMPERVAN'S EQUIPMENT

## Use of the burners

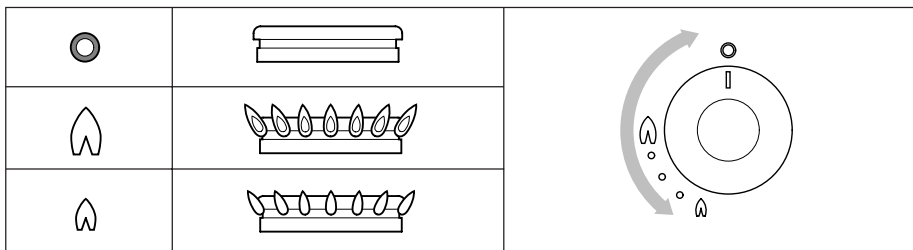

For the exact location of the control knob, see Main components.

### Turning on:

- Push and turn the control knob.
- Turn the control knob anti-clockwise to the full rate position.
  - For spark ignition models: Push the ignition button.
  - For non-ignition models: Hold a lit match or gas match to the burners.
- Keep the control knob pressed for about 10-15 seconds and then release it.
- Adjust the height of the flame.



If the burner accidentally extinguishes turn the control knob to the 0 position and wait at least 1 minute before re-igniting the burner.



If the burner has not lit within 15 seconds turn the control knob back to the 0 position and release it. Wait at least 1 minute and repeat the steps above to turn on the appliance.

### Turning off:

- Turn the control knob clockwise to the 0 position to turn off the burner.



Always make sure the control knob is in the 0 position when you have finished using the gas burners.



Do not shut the glass lid when the burners are lit or still warm.

## Use of the electric hotplate (if applicable)

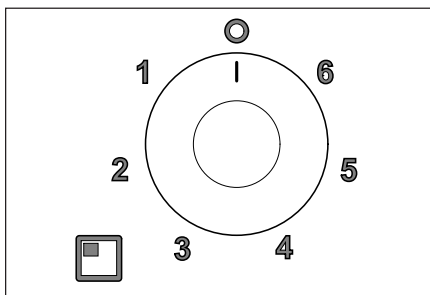

For the exact location of the control knob, see Main components.

### Turning on:

- Rotate the control knob either clockwise or anti-clockwise to the required position (1-6).

For maximum efficiency, a correctly sized pan with a flat heavy gauge base should be used. The pan size should be the same or slightly larger than the hotplate (up to 1 1/2.5cm oversize).

### Turning off:

- Turn the control knob to the 0 position to turn off the hotplate.



Always make sure the control knob is in the off position when you have finished using the hotplate.



Do not shut the glass lid when the hotplate is turned on or still warm.

# HOW TO USE YOUR CAMPERVAN'S EQUIPMENT

## Use of the grill

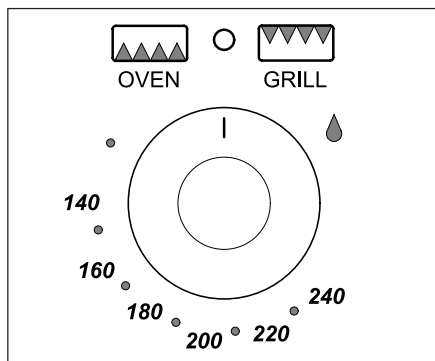

For the exact location of the control knob, see Main components.

### Turning on:

- Open the door and push the control knob.
- Continue pressing the control knob and turn it anti-clockwise to the full rate position.
  - For spark ignition models: Push the ignition button.
  - For non-ignition models: Hold a lit match or gas match to the burner.

Keep the control knob pressed for about 10-15 seconds and then release it.

- Adjust the required heat setting.

The grill is only to be used at its nominal heat setting.

- Depending on the food to be cooked, the correct grilling height can be achieved by inverting the pan trivet into either the high or low position.
- The grill pan supplied is multi-functional, for use in grill or oven and the handle design allows removal or insertion whilst the pan is in use. Always remove the handle when the pan is in use.
- Place the shelf in the required position.

The grill door must remain open when lighting and using the grill.

If the burner accidentally extinguishes turn the control knob to the 0 position and wait at least 1 minute before re-igniting the burner.

- If the burner has not lit within 15 seconds turn the control knob back to the 0 position and release it. Wait at least 1 minute and repeat the steps above to turn on the appliance.
- Although the grill heats up quickly, it is recommended that a few minutes preheat be allowed. A 12V cooling fan operates automatically above the grill cavity.
- It is normal for the flames on this burner to develop yellow tips as the grill heats up.

### Turning off:

- Turn the control knob clockwise to the 0 position to turn off the burner.



Always make sure the control knob is in the 0 position when you have finished using the grill.

## Use of the oven

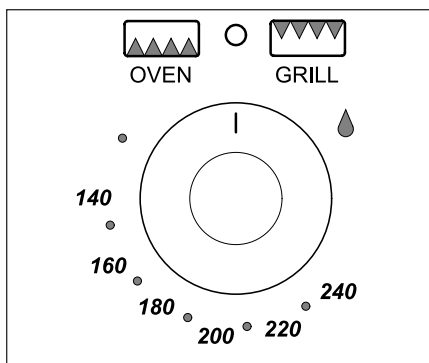

For the exact location of the control knob, see:

### Turning on:

- Open the door and push in the control knob.
- Continue pressing the knob and turn it anti-clockwise to the full rate position. (240°C gas mark 9).
  - For spark ignition models: Push the ignition button.
  - For non-ignition models: Hold a lit match or gas match to the burner.



# HOW TO USE YOUR CAMPERVAN'S EQUIPMENT

- Keep the control knob pressed for about 10-15 seconds and then release it.
- Adjust the required heat setting.
- Place the oven shelf in the required position and close the door.

Ignition must always be carried out with the oven door open.

If the burner accidentally extinguishes turn the control knob to the 0 position and wait at least 1 minute before re-igniting the burner.

If the burner was not lit within 15 seconds turn the control knob back to the 0 position and release it. Wait at least 1 minute and repeat the steps above to turn on the appliance.

Although the oven heats up quickly, a 10-minute preheat is recommended. The oven should reach full temperature in about 15-20 minutes.

## Turning off:

- Turn the control knob clockwise to the 0 position to turn off the burner.



Always make sure the control knob is in the 0 position when you have finished using the oven.

## Safe cooking

- Do not allow cooking vessels to overlap the edges of the appliance - use the correct sizes of pans and position them centrally over the burners.

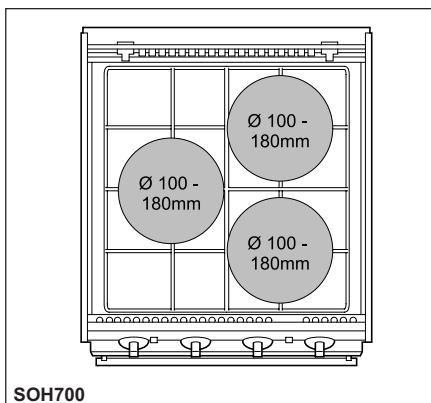

SOH700

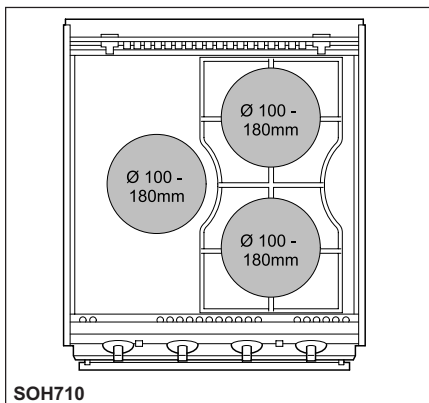

SOH710

- Ensure that there is at least a 10mm gap between the pans and the edges of the hob.
- Turn the pans so that the handles do not overhang the front of the appliance.
- Ensure that the flame of the gas burner heats the bottom of the pan, not the sides.
- The pans and trays supplied with this appliance are the maximum sizes. Do not use larger pans and trays. They may restrict good circulation of heat, which may increase cooking times.
- The oven shelf allows good circulation at the rear of the oven.
- A raised bar at the rear of the shelf prevents trays or dishes making contact with the back of the oven.
- To remove a shelf, pull it forward until it stops, raise at the front and remove.
- To place a shelf in the oven, lower it at the front and slide it backward until it stops.
- Do not leave the appliance unattended when in use.
- Do not use the appliance while the vehicle is moving.
- Turn the control knob back to the 0 position after cooking.
- Keep the appliance clean and prevent accumulation of grease and food scraps.

# HOW TO USE YOUR CAMPERVAN'S EQUIPMENT



Never cover slots or holes in the appliance and never cover a shelf with materials such as aluminium foil. That restricts the airflow and may cause carbon monoxide poisoning.





The food shelves and trays in the appliance are hot during and after use. Allow all parts to cool before touching them, as this can cause serious injury. Always use oven gloves when removing the shelves and trays.

## Temperature control

The temperature in the oven is controlled by a thermostatic gas tap and is variable over the range 130°C to 220°C.

The table overleaf provides a guide to the approximate temperatures at each of the shelf positions with respect to the gas mark setting. Good use can be made of the temperature variation between the shelf positions, as several dishes requiring different temperatures may be cooked at the same time. In this way maximum benefit can be obtained from the gas used to heat the oven.

## Temperature Zones

| Gas Mark  |  |  |  | Dish                             |
|-----------|---|---|---|----------------------------------|
| 1/4 - 1/2 | 90°C  | 110°C   | 130°C   | Meringues                        |
| 1         | 110°C   | 130°C   | 150°C   | Stewed fruit                     |
| 2         | 120°C   | 140°C   | 160°C   | Rich fruit cake, rice pudding    |
| 3         | 130°C   | 150°C   | 170°C   | Baked custard, shortbread finger |
| 4         | 140°C   | 160°C   | 185°C   | Victoria sponge                  |
| 5         | 155°C   | 180°C   | 200°C   | Whisked sponges, ginger nuts     |
| 6         | 170°C   | 190°C   | 215°C   | Short crust pastry               |
| 7         | 185°C   | 210°C   | 220°C   | Bread, scones, flaky pastry      |
| 8         | 200°C   | 220°C   | 220°C   | Puff pastry                      |



Care should be taken not to overload the oven, allow adequate spacing to ensure free circulation of heat.



When roasting with aluminium foil ensure the foil does not impair circulation of heat or block any oven flue outlet.

# HOW TO USE YOUR CAMPERVAN'S EQUIPMENT

---

## REFRIGERATOR

### Safety

- This appliance may be used by children aged 8 years or older and persons with reduced physical, sensory or mental capabilities and/or lack of experience and knowledge only if they are supervised or have been given instructions on the safe use of this appliance and understand the potential hazards.
- Keep children younger than 8 years away from the appliance, except under constant supervision.
- Do not allow children to play with the appliance. Children can become trapped and suffocate.
- Do not allow children to clean or maintain this equipment unattended.
- Use only parts supplied by the manufacturer.
- Do not change or adjust anything on the appliance, unless the change is authorised by the manufacturer or its representative.
- Use the appliance for cooling and freezing only and not for anything else. Follow the instructions in this manual. The manufacturer cannot be held liable for damage resulting from improper use or incorrect setting of the controls. If the instructions have not been followed, warranty claims will not be accepted.
- This appliance is designed for 12V DC supply voltage. Do not attempt to run the refrigerator on any other voltage or means of supply.
- Build-up of dust on the condenser will reduce the performance of the appliance and increase the risk of overheating of the cooling system. Have the condenser and cooling fan cleaned by qualified service personnel if you suspect poor performance.
- Never open or damage the refrigerant circuit of the cooling system at the back or on the inside of your appliance. The cooling system is pressurised and contains flammable substances.
- Do not use electrical appliances in the appliance.
- Do not store explosive substances such as aerosol cans with a flammable propellant in this appliance.
- The maximum load of the large shelf is 12kg and the maximum load of the small shelf is 6kg.
- Never expose the appliance to moisture.
- Keep ventilation openings, in the appliance enclosure or in the built-in structure, clear of obstruction.
- Do not use mechanical devices or other means to accelerate the defrosting process, other than those recommended by the manufacturer.
- This refrigerator is intended for use in mobile leisure vehicles.

# HOW TO USE YOUR CAMPERVAN'S EQUIPMENT

## Main Components

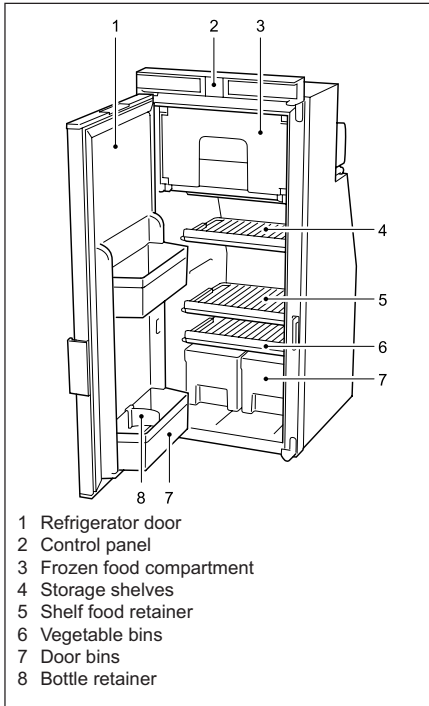

## Control panel

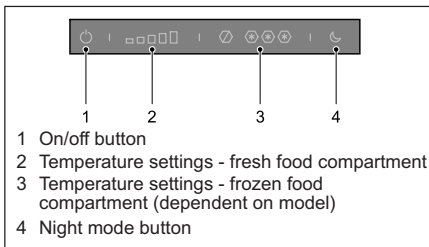

## Before use

Before using the appliance:

- Ensure that all packaging materials have been removed.
- Clean the inside of the refrigerator properly with warm water and household detergent and dry carefully with a soft cloth.
- Ensure that the DC electricity supply is connected and turned on.

## Switching on the refrigerator

To switch on the refrigerator:

- Push the on/off button and hold it for a few seconds.



- After a few seconds the control panel will change to stand-by and locked mode. The blue on/off button indicates the refrigerator is still in function.
- To switch off the refrigerator, push and hold the on/off button for a few seconds.
- For optimal performance, switch on the refrigerator 4 hours before placing food.

## Selecting cooling level

To select:

- Unlock the control panel.
- Press the fresh food or frozen food area and hold it for a few seconds until the icons start blinking.

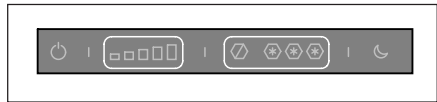

- Slide or press the icons to select the desired level.

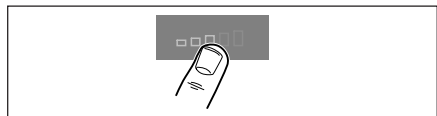

- After a few seconds, the control panel will save the settings and go to the locked stand-by mode.
- When display is locked, the icons will turn off, only on/off and night mode will stay illuminated.
- Active running time of the refrigerator depends on the temperature, size and state of the battery, electrical load of other devices in the vehicle, content of the refrigerator and frequency of use.

# HOW TO USE YOUR CAMPERVAN'S EQUIPMENT

- When the vehicle is exposed to full sun light, it is strongly recommended to apply proper ventilation in the vehicle.

## Selecting night mode

The refrigerator will select the lowest noise setting where possible. When the refrigerator needs to run harder (due to higher ambient temperatures and/or warm products), it may result in an increase of noise. You can switch on the night mode to reduce the noise to a minimum. The cooling down time might take longer. The blue light indicates the night mode is activated.

- First unlock the control panel.
- Push the night mode button.



Use night mode only when temperatures in the vehicle are below 30°C. The night mode will switch off automatically after 12 hours. When switching off the night mode manually, it will go to automatic temperature control.

## Use of the frozen food compartment

For model T2090 only: the frozen food compartment can be used to store perishable foodstuffs or frozen foods.

Refer to Selecting cooling level for more information on the regulated frozen food compartment for the other models.

- Never keep carbonated liquids in the frozen food compartment.

Never eat ice-cubes or popsicles directly out of the frozen food compartment. This can cause burns.

For model T2090 only: the temperature in the frozen food compartment cannot be guaranteed if the refrigerator performs in a vehicle interior temperature below 16°C. Food might defrost. Raise the temperature setting to minimal level 3 if you expect vehicle interior temperatures below 20°C and want to maintain freezing temperature in the frozen food

compartment. As a consequence the temperature of the fresh food compartment will become lower. Raising the vehicle interior temperature will also contribute to a lower temperature in the frozen food compartment.

## While driving

- Make sure no products in your refrigerator can move while driving. Secure the bottles in the door and/or the drawer with the bottle retainer and drawer dividers. The shelf food retainers hold products on the shelves while driving.

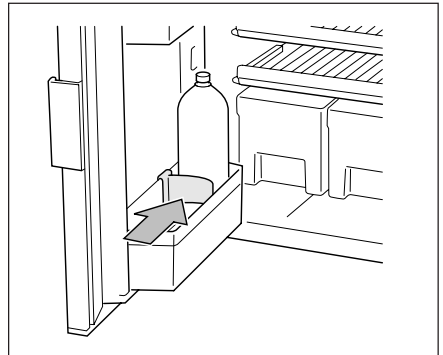

- When you push to close the door of the refrigerator, the door locks automatically. The door lock will prevent the door from opening while driving.

# HOW TO USE YOUR CAMPERVAN'S EQUIPMENT

## Troubleshooting

| Problem  | Possible cause  | Solution  |
|--|---|---|
| Refrigerator is not cooling, compressor will not run at all              | Battery voltage too low   | Recharge battery  |
|  | Start delay of 1 minute (no issue)                              | Wait 1 minute   |
|  | Overheat due to high ambient                                    | Turn off refrigerator for 1 hour, vent the vehicle, switch to day mode                              |
|  | Vehicle fuse has blown  | Check fuse rating, replace with 15A   |
| Frozen food compartment not freezing                                     | Interior temperature in vehicle is lower than 16°C              | Raise the temperature of the vehicle inside and/or select a higher cooling level to minimal level 4 |
| Refrigerator is not cooling, compressor starts but switches off directly | Overheat due to high ambient temperature                        | Turn off refrigerator for 1 hour, vent the vehicle, switch to day mode                              |
| Refrigerator is overcooling  | Temperature setting too high                                    | Choose a lower temperature setting  |
| Refrigerator is not cooling, compressor runs continuously                | Go to a service centre  |   |
| Refrigerator has insufficient cooling                                    | Overheat due to high ambient temperature                        | Turn off fridge for 1 hour, vent the vehicle, switch to day mode                                    |
|  | Ventilation openings, complete or partially blocked             | Clean or remove blockage  |
|  | Door is not properly closed                                     | Close door, make sure door seal is in good order  |
|  | Too much ice on evaporator (more than 3mm)                      | Defrost evaporator, make sure door seal is in good order  |
| Refrigerator makes more noise in night mode                              | High ambient temperature (more than 30°C)                       | Wait until the refrigerator has reached the selected temperature setting.                           |
|  | Warm products have been placed inside the refrigerator          |   |
|  | Refrigerator is turned on after it has been off for a long time |   |
|  | A low temperature setting is selected.                          |   |

# HOW TO USE YOUR CAMPERVAN'S EQUIPMENT

## MICROWAVE (Where Fitted)

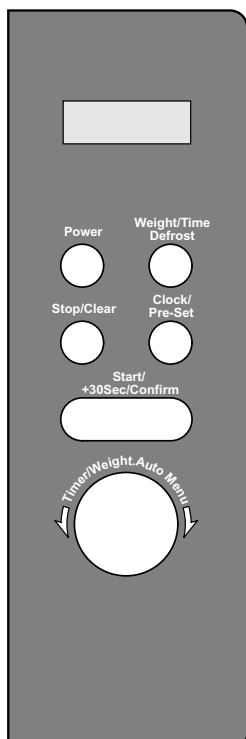

**MENU ACTION SCREEN** Cooking time, power, auto and the clock time are displayed.

**POWER** Press to select the power level for microwave cooking.

**WEIGHT/TIME DEFROST** Press this button to input weight for defrosting.

**CLOCK/PRE-SET** Press this button to input weight for defrosting.

**STOP/CLEAR** Press to stop the cooking process.

**TIMER/WEIGHT . AUTO MENU** Rotate to select the cooking time and the auto menus.

**START/+30SEC/CONFIRM** Press this button to start the cooking process and confirm when programming.

**DOOR OPEN** Pull the handle to open the door.

## Microwave cooking

- 1 Press the "POWER" button once and "P100" will display and flash.
- 2 Turn the "TIMER/WEIGHT" to select the microwave power. "P100", "P90", "P80", "P70", "P60", "P50", "P40", "P30", "P20", "P10" and "P00" will display in order.
- 3 Press "START/+30 SEC" to confirm.
- 4 Turn the "TIMER/WEIGHT" dial to adjust the cooking time. (The time setting should be between 0:05-95:00).
- 5 Press "START/+30 SEC" to start the cooking process.

| Press power button | Cooking power |
|--------------------|---------------|
| P100               | 100%          |
| P90                | 90%           |
| P80                | 80%           |
| P70                | 70%           |
| P60                | 60%           |
| P50                | 50%           |
| P40                | 40%           |
| P30                | 30%           |
| P20                | 20%           |
| P10                | 10%           |
| P00                | 0%            |

To stop the cooking process at any time press the "STOP/CLEAR" button.

For further appliance information please refer to microwave user manual.

# HOW TO USE YOUR CAMPERVAN'S EQUIPMENT

## SMOKE ALARM

### Operation

#### Normal Condition

The red LED on the front should flash every 40 seconds to show that the alarm is active.

#### Lower Power Pack Condition

**IMPORTANT:** Your smoke alarm requires the power pack to have sufficient capacity of power to operate correctly.

Should your smoke alarm enter a low power pack condition, the unit will emit an audible 'chirp' once every 40 seconds. When this occurs, we recommend you replace the alarm immediately. Your smoke alarm will continue to warn of this low power pack for at least 7 days, however, failure to change the alarm after this time would mean your smoke alarm may have insufficient power to alert you in a real fire situation. When the alarm is removed from the base plate the power pack will automatically deactivate and the low power warning chirp should stop, allowing you to dispose of the alarm.

#### Low Battery Warning Silence

This feature can temporarily silence the low battery chirp for 8 hours which is particularly useful if the warning begins during the night. This feature may be repeated up to 10 times, but is not a substitute for replacing the smoke alarm.

#### Alarm Test

The alarm must be properly attached to the base plate before it can be tested.

- Press the test button in the centre and release.

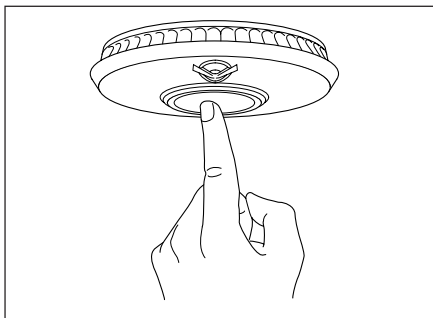

- The unit will give an audible alarm consisting of 2 cycles of 3 loud beeps, then stop automatically.

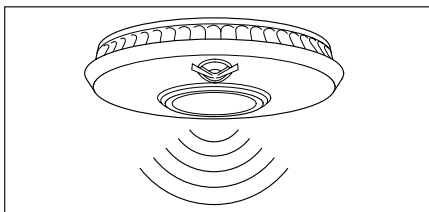

- The red LED on your alarm will flash rapidly during the audible signal.

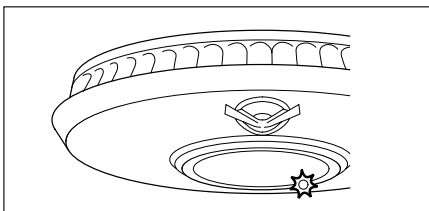

**Note:** The test button accurately tests the alarm's smoke sensing circuit, there is no need to test your alarm with smoke. If your smoke alarm fails to give an audible test signal, please refer immediately to the trouble shooting guide at the end of this manual.

**WARNING:** You should test your smoke alarm every week.



# HOW TO USE YOUR CAMPERVAN'S EQUIPMENT

## ALARM SMART SILENCE™

**DANGER:** If your smoke alarm emits the full alarm signal and you are not testing the unit, the smoke alarm is warning you of a potentially dangerous situation that requires your immediate attention. Only use the alarm silence function after making sure that there is no ongoing fire emergency situation. Do not block the vents on the alarm or disable the smoke alarm in any way, as this will remove your protection. Smoke alarms can sometimes react to cooking fumes or other non emergency situations. Your smoke alarm features “Smart Silence” technology. In the event of a known false alarm your smoke alarm can be temporarily silenced by pressing the central test button. Your alarm will automatically return to full sensitivity within 10 minutes.

**Note:** If the level of smoke reaching the alarm is very high, the alarm silence will be overridden and the alarm will continue to sound.

- Press and release the silence button, the alarm sound will shortly stop.

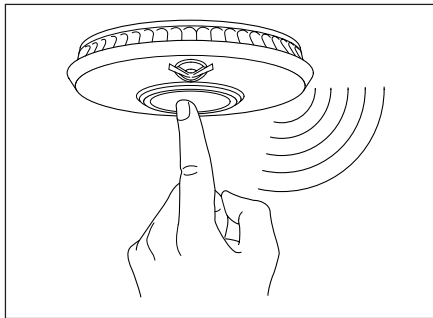

- Your alarm will silence and enter into a reduced sensitivity reset cycle for approximately 10 minutes.

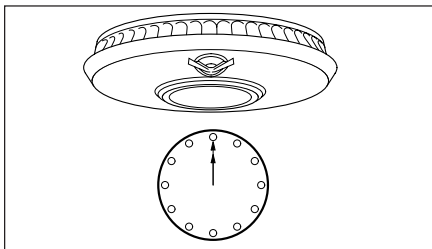

- During the reduced sensitivity reset cycle, the red LED on your alarm will continue to flash more rapidly than normal, approximately once every second.

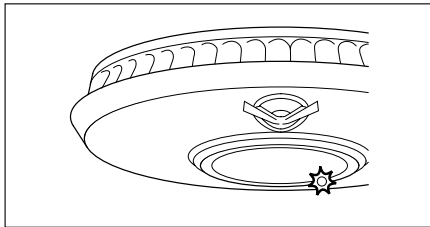

- Your alarm will automatically return to full sensitivity on completion of the reset cycle and the red LED will revert to flashing once every 40 seconds.

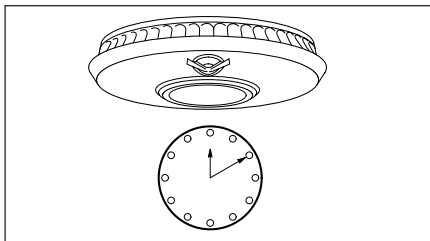

**DANGER:** Never ignore any alarm. Ignoring the alarm may result in injury or death. If your smoke alarm activates and alarms and you are not absolutely certain of the source of the smoke, get everyone out of the caravan immediately.

## LOW BATTERY WARNING SILENCE

Low battery warnings often start at night or when it may be inconvenient to replace your alarm. You can silence the audible chirp for a period of 8 hours by pressing the test button. Your smoke alarm will still detect smoke during this time of low battery warning silence. However, it is recommended that you replace your alarm immediately and certainly within 7 days, as your alarm may then have insufficient power to warn you of a real fire situation after this time.

**WARNING:** Your smoke alarm cannot be silenced if the chirp is indicating a fault. In this instance, the unit should be replaced immediately to ensure protection in the event of a fire.

# HOW TO USE YOUR CAMPERVAN'S EQUIPMENT

## MAINTENANCE

Your smoke alarm has been designed to be as maintenance-free as possible, however there are several things you must do to keep it working properly.

**CAUTION:** Your smoke alarm is a sealed electrical device and no attempt should be made to open the case. Attempting to open the case will invalidate your warranty.

### Testing

Test your smoke alarm once every week see 'Alarm Test'. Any test failures should be reported to the Technical Support Team.

### Cleaning

As a minimum your smoke alarm should be cleaned once every 3 months using your vacuum cleaner fitted with the soft brush attachment.

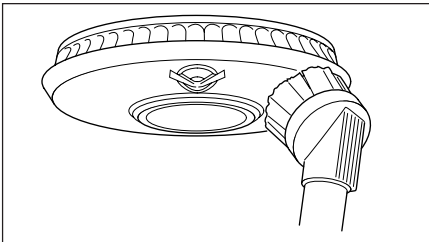

**WARNING:** Your smoke alarm may false alarm when it is being cleaned using a vacuum cleaner.

**IMPORTANT:** Do not use solvents or cleaners on your smoke alarm, as they may cause damage to the sensor or circuitry. The unit can be wiped with a slightly damp cloth.

**CAUTION:** Do not paint the smoke alarm as this may block the openings and prevent smoke from entering the sensor.

## CARBON MONOXIDE ALARM

### Carbon monoxide and how it can affect you and your family

Carbon monoxide is a dangerous poisonous gas that kills hundreds of people each year and injures many more. It is often referred to as the silent killer because it has no odour or taste and cannot be seen. Like oxygen, CO enters the body through the lungs during the normal breathing process. It competes with oxygen by replacing it in the red blood cells, thereby reducing the flow of oxygen to the heart, brain and other vital organs. In high concentrations, CO can kill in minutes.

Many cases of reported carbon monoxide poisoning indicate that while victims are aware they are not feeling well, they become disorientated and unable to save themselves by either exiting the building or calling for assistance. Exposure during sleep is particularly dangerous because the victim does not wake up.

### Symptoms of CO poisoning

The following symptoms may be related to CO poisoning which all household members should be made aware of:

- Mild Exposure: Slight headache, nausea, vomiting, fatigue (often described as 'flu-like' symptoms).
- Medium Exposure: Severe throbbing headache, drowsiness, confusion, fast heart rate.
- Extreme Exposure: Unconsciousness, convulsions, cardiorespiratory failure, death.

Your CO detector monitors the level of CO as parts per million (ppm) in the atmosphere surrounding the detector.

- |        |  |
|--------|--|
| 35ppm  | The maximum allowable concentration for continuous exposure for healthy adults in any 8 hour period, as recommended by the Occupational Safety and Health Administration (OSHA). |
| 200ppm | Slight headache, fatigue, dizziness, nausea after 2-3 hours.   |
| 400ppm | Frontal headaches within 1-2 hours, life threatening after 3 hours.  |

# HOW TO USE YOUR CAMPERVAN'S EQUIPMENT

---

800ppm Dizziness, nausea and convulsions within 45 minutes.  
Unconsciousness within 2 hours.  
Death within 2-3 hours.

Should you suspect CO may be affecting you or your family, open the doors and windows of your caravan to ventilate, turn off your appliances and evacuate the premises. At this time the authorities should be contacted to locate the source of the carbon monoxide before re-entering the caravan. Medical attention should be sought for anyone suffering the effects of CO poisoning.

## Common sources of CO

- Oil and gas boilers
- Portable generators
- Oil or solid fuel cookers
- Barbecues
- Clogged chimneys
- Wood or gas fireplaces
- Cigarette smoke
- Gas appliances
- Any fossil fuel-burning appliance

**WARNING: This carbon monoxide detector is not a combustible gas detector, nor a smoke detector. Please install the proper detectors to detect combustible gases, or smoke.**

This CO detector should not be seen as a substitute for the proper installation, use and maintenance of fuel-burning appliances (including appropriate ventilation and exhaust systems), nor the sweeping of chimneys.

**WARNING: Variables relating to your fuel-burning appliances can change at any point eg. the flue or chimney could suddenly become blocked or damaged, appliances may stop running correctly or circumstances in neighbouring properties may change resulting in the presence of carbon monoxide. For this and other reasons do not use this carbon monoxide detector on an intermittent basis, or as a portable detector or an intermittent basis, or as a portable detector for trying to trace one source of the spillage of combustion products from fuel-burning appliances or from chimneys.**

## Do not:

- IGNORE ANY WARNING FROM YOUR CO DETECTOR!
- Burn charcoal inside your home, caravan, tent or cabin.
- Install, convert or service fuel-burning appliances without proper knowledge, skill and expertise.
- Use a gas cooker for heating a room.
- Operate unvented gas burning appliances using paraffin or natural gas in closed rooms.
- Operate petrol-powered engines indoors or in confined areas.
- Barbecue indoors, or in an attached garage.
- Ignore a safety device when it shuts an appliance off.

## Always:

- Buy appliances accepted by a recognised testing laboratory.
- Install appliances according to the manufacturer's instructions.
- Have appliance installations carried out by professionals (for gas appliances engineers should be registered on the Gas Safe register).
- Have your appliances checked regularly by a qualified service engineer.
- Have your chimneys and flues cleaned professionally every year.
- Make regular visual inspections of all fuel-burning appliances.
- Open windows when a fireplace or oil/solid fuel cooker is in use.
- Only install CO detectors that meet the requirements of EN 50291-1:2018 and EN 50291-2:2019 in your home.
- Be aware of CO poisoning symptoms.
- Educate yourself and your family on the sources and symptoms of CO poisoning and how to use your carbon monoxide detector.

# HOW TO USE YOUR CAMPERVAN'S EQUIPMENT

## ALARM ACTIVATION

To activate your CO alarm, pull the disabling tab out of the device.

Wait up to 1 minute for the green LED to flash to confirm the device is active.

Press the Test/🔊✕ button to test the alarm. The alarm will sound. (The alarm will not sound before the 1 minute activation period is complete).

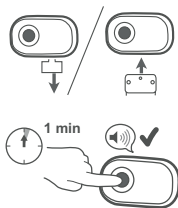

## ALARM SILENCE

**WARNING: If the cause of an alarm is unknown, ventilate and evacuate your property before using this feature.**

Press the Test/🔊✕ button.

The sounder will stop and enter into Silence mode for 5 minutes.

**Note:** The alarm will not silence if more than 150ppm has been detected.

Silence mode can only be activated once (until CO returns to negligible levels).

Once the Silence mode is enabled, if the CO level rises above 150ppm the device will exit Silence mode and continue to sound.

After 5 minutes if the CO level is still high, the device will continue to sound.

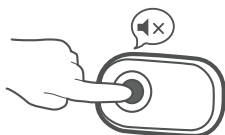

## Understanding the products indicators

The higher the concentration of carbon monoxide detected by the detector, the quicker it will respond. When sufficient carbon monoxide is detected a loud audible signal (85 dB at 3m) will be emitted and the Alarm LED will flash red once every second.

## The alarm will sound:

- Between 60 and 90 minutes when exposed to 50ppm of CO.
- Between 10 and 40 minutes when exposed to 100ppm of CO.
- Within 3 minutes when exposed to 300ppm or more of CO.

## ALARM IN ABSENCE

When a CO alarm has occurred in your absence, your device will notify you so that you can take appropriate action at the earliest opportunity.

If the device is not silenced during an alarm, it will continue to sound until the CO level has reduced to below 50ppm.

After which, the device will flash the red warning light twice every 20 seconds to indicate that dangerous CO levels have been detected in your absence.

The red warning light will continue to flash for 7 days if the Test/🔊✕ button is not used to cancel it.

Red flash: 🌟 --> 🌟

## MAINTENANCE

**Test the alarm every month. Press the Test button. The alarm will sound.**

If the alarm does not sound. Contact Technical Support.

**Note:** The above method fully tests all elements of the alarm. Additional, but not essential testing may be conducted using the Sense-CO Test mode and CO gas.

To ensure your alarm is tested correctly using low concentrations of test CO gas, please follow these instructions.

1. To activate Sense CO testing, triple press your alarm test button. **Please note:** The request to enter Sense CO mode will timeout after two minutes if no further action is taken.
2. Once Sense CO is activated, the CO acquisition task is performed constantly. The yellow 'ventilate' LED light will flash once per second and the unit will provide indications if the CO level is >30ppm during the following two minutes.

# HOW TO USE YOUR CAMPERVAN'S EQUIPMENT

3. If levels of CO are detected, the alarm will sound four loud beeps, with a five second gap between each beep, before another four loud beeps.

As campervans have an increased risk of carbon monoxide ingress through air vents due to the nearby presence of other vehicles, engines, generators or barbecues, this method of testing is highly recommended for the industry.

Please do not use any other test method than what is detailed in the product manual.

Do not tamper with the alarm as this could cause electric shock or malfunction.

**CAUTION:** Sensor testing should only be performed by a responsible adult. This test should only be performed annually.

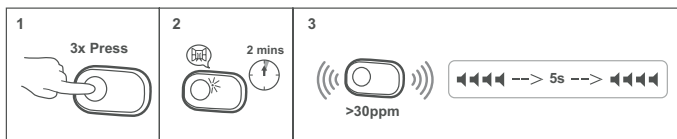

Vaccum your alarm every 3 months.

Do not use cleaners or solvents.

Do not paint the alarm.

**Replace the alarm every 10 years.**

The replacement date can be found next the the 'REPLACE BY' marking on the alarm.

## SYSTEM STATUS INDICATORS

Your CO alarm constantly checks the accuracy of its sensor and circuitry. All alarms must indicate when there is a fault or if the battery power is low (identified by the ! icon).

If any of the settings are found to be incorrect or if the batteries become low, the device will sound an audible chirp and display an amber flash pattern for up to 30 days.

**IMPORTANT:** This does not mean that the alarm has detected carbon monoxide. If there is a fault, your CO alarm will display the following fault indication patterns.

|             | Audible pattern   | Amber LED/LCD             | Action required                         |
|-------------|-------------------|---------------------------|---|
| Low battery | 1 beep/min        | 1 amber flash/min         | Replace the batteries                   |
| Fault       | 2 rapid beeps/min | 2 rapid amber flashes/min | May not detect CO - replace immediately |
| End of life | 3 rapid beeps/min | 3 rapid amber flashes/min | May not detect CO - replace immediately |

If your alarm is within warranty, contact Technical Support.

**Your CO alarm must be replaced immediately if there is a fault or the device indicates End of Life. An alarm with a fault or signalling End of Life may not detect a CO leak.**

## SLEEP EASY™ SILENCE FEATURE

If a low battery warning 'chirp' occurs at night, it may be inconvenient to replace the batteries or alarm. You can silence the 'chirp' by pressing the Test/⏏ button. The alarm will silence for 8 hours and the amber LED will continue to flash.

**Note:** You can silence your device a maximum of 10 times.

If your alarm is an FA3313 and is signalling low batteries, replace the batteries as soon as possible.

Once the batteries have been replaced, the Sleep Easy feature will be disabled for 30 days.

**Note:** During Sleep Easy mode the unit still detects CO and will alert you to any new faults.



# HOW TO USE YOUR CAMPERVAN'S EQUIPMENT

## ROOFLIGHTS

### MPK Rooflight (Where Fitted)

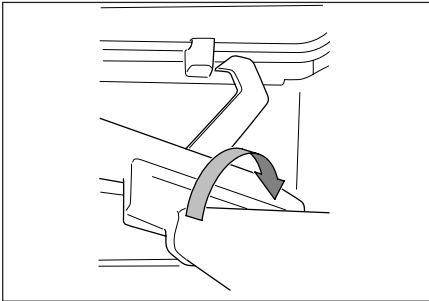

### Operation

To open the rooflight, both pleated blinds must be open.

Grip the crossbar in the middle and turn it towards the opening side. Now the rooflight can be opened by pushing the crossbar. As soon as you release the crossbar, the opening mechanism snaps into this position.

To close the rooflight, turn it again and push it back in the opposite direction. When the end position is reached, the rooflight is locked automatically.

- Keep the pleated blinds open when driving to avoid driving noise and damage from the airstream.
- To avoid heat accumulation do not close blind completely during the day. Open both pleats when not using the vehicle.

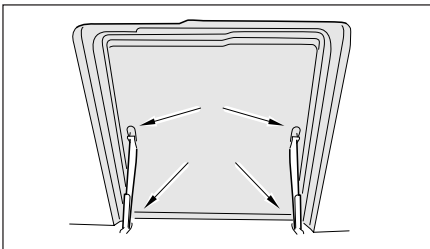

### Cleaning

For easier cleaning, the dome can be removed from the inner frame by releasing the four plastic split pins.

Do not loosen any screws that are used to fasten the dome or the opening mechanism.

Use only clear water and a soft sponge.

Solvents may attack the plastic and make it brittle.

After cleaning, maintain the sliding surfaces with a thin layer of Vaseline or WD40. This makes the extension mechanism glide more easily. The rubber seals can be maintained with talcum powder.

Pay attention that the pins positively click into the locked position when re-installing the dome. The lever arm pins should be re-installed with the flat side towards the dome.

Clean the pleated blinds with a soft brush, dry cloth or feather duster.

We strongly advise against wet cleaning, as this can damage the insect screen and blackout pleated blind.

# HOW TO USE YOUR CAMPERVAN'S EQUIPMENT

---

## Midi Heki Rooflight (Where Fitted)

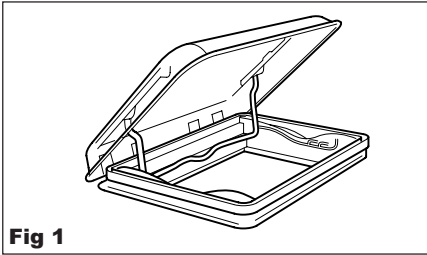

**Fig 1**

- (i) To open, push the large central button (Fig 2).

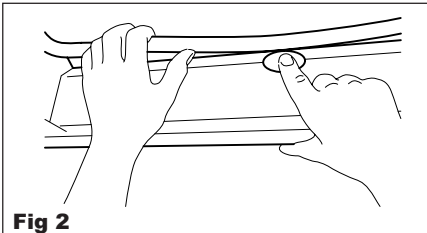

**Fig 2**

- (ii) Whilst depressed, slide the bar to the desired position and locate into the stops provided (Fig 3).

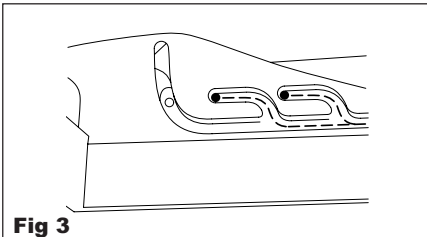

**Fig 3**

## Door Flyscreen

The exterior door flyscreen can be opened or closed from both inside and outside of the Campervan and does not restrict door openings.

When opening or closing the door flyscreen use the finger grip provided.

# HOW TO USE YOUR CAMPERVAN'S EQUIPMENT

---

## WINDOWS

Your new Campervan will be fitted with Polyplastic opening windows.

### Polyplastic Window Opening

- (i) In order to open the Polyplastic window it is only necessary to move the catch upwards and release the catch from the backing plate.
- (ii) The Polyplastic window should remain in the open position once opened, however if it does not then tighten the friction control on the window stays to increase the holding force.
- (iii) The Polyplastic window is also fitted with a night ventilation position where the catch is set to the centre position on the backing plate; in this position it may be possible for rain to enter the campervan in adverse conditions.

## SHOWER

### Using your Campervan Shower

To safely enjoy showering in your new campervan, the following guidelines should be used.

- Advise others that you are planning to have a shower and that they should not use other taps whilst you are showering.
- Ensure there is a sufficient supply of cold water available.
- Divert the shower head or move to the side, turn on the shower, carefully test the temperature with your hand and regulate the temperature as necessary before standing underneath the shower.
- Supervise closely the young, elderly and those with reduced mentally or sensory impairment.

**CAUTION: Water may be very hot.**

## TAPS

### Kitchen Taps

Your new campervan will be fitted with a mixer tap.

**CAUTION:** The water temperature could be very high so do not lift the lever with the tap turned to the full left position. For winter storage and to prevent frost damage the tap swivel must be left in the centre up position.

### Washroom Taps And Showers

Your campervan is supplied with a combined mixer tap with retractable shower head.

#### Note:

- The water temperature could be very high so do not lift the lever with the tap turned to the full left position.
- For winter storage and to prevent frost damage the tap swivel must be left in the centre up position.



# HOW TO USE YOUR CAMPERVAN'S EQUIPMENT

## INTERNAL DOORS

### Toilet/Shower Room Doors

#### Operation from within the shower room

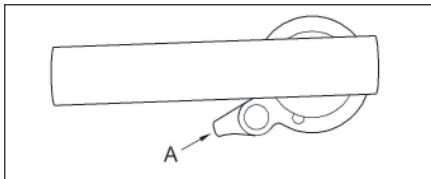

To lock the door, push the small lever down (identified in the drawing as A) then to unlock, push this lever back to the original position.

#### Operation from outside the shower room

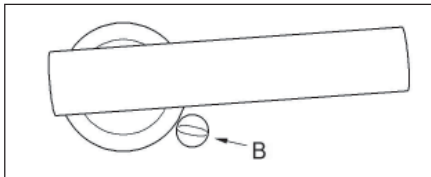

To open and close the door, push the lever down.

If the door is locked and needs to be opened, it can be opened by inserting a coin into the lower slot (identified in the drawing B) and turning the slot.

#### Other Internal Doors

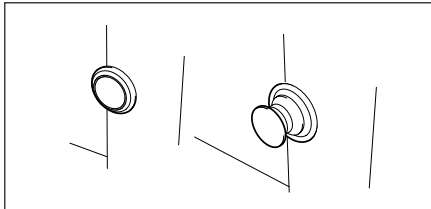

Other internal doors such as the wardrobe and table storage locker are fitted with a 2-position button lock. Push the button to lock the door and the button should remain flush with the door. Push the button again to release and the button should then protrude from the door surface.

#### Paddle Latch

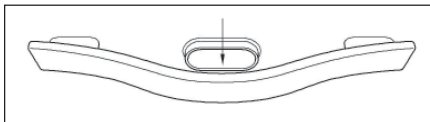

To open the locker, push the paddle downwards and pull the handle towards you.

#### Concealed Latch

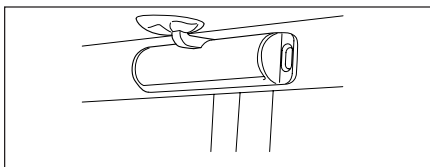

To open the locker, press the latch and pull the door towards you.

#### Magnetic Catches (Where Fitted)

Magnetic catches work on contact with the metal plate on the rear of the door. Simply close the door until the magnet engages and holds the metal plate. Pulling the door towards you with a moderate force will be sufficient to disengage the magnetic catch and open the door.

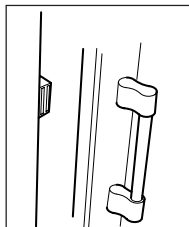

## THETFORD C-260 CASSETTE TOILET RANGE

### Introduction

The Thetford Cassette Toilet is a high quality product. The toilet forms an integral part of your campervan bathroom, thanks to its functional design which combines modern styling and ease of use. The C-260 Cassette Toilet is manufactured from high quality synthetic materials which makes it a durable, user and maintenance friendly toilet.

The toilet is made up of two parts: a permanently fixed part and a Waste Holding Tank that is accessible from the outside. The removable Waste Holding Tank is located under the toilet bowl and can be removed via a door on the outside of the campervan. The Thetford Cassette Toilet is the solution to the sanitary problem in your campervan!

The operating instructions cover Thetford Cassette Toilet models C-260S, C-260CS (models connected to the vehicle's central water tank) and C-260CWE (model with its own flush-water tank). There are differences in the use of these models. Please ensure that you follow the instructions that apply to your toilet model.

### Preparing for use (standard)

1. Open the access door on the outside of your campervan.
2. Remove the Waste Holding Tank by pulling the safety catch (which holds the tank in place) upwards.
3. Pull the Waste Holding Tank outward to the stop. Tip it slightly and take the tank fully out.
4. Place the tank upright and turn the rotating emptying spout upwards. The emptying spout ensures that the tank can be easily and hygienically emptied.
5. Remove the cap, with the measuring cup inside, from the emptying spout and pour the correct dosage of Thetford toilet fluid (see product label) into the holding tank. This avoids unpleasant smells and keeps the inside of the tank clean. Next add approximately 2 litres of water - enough to ensure that the bottom of the Waste Holding Tank is covered. For more information on Thetford toilet fluids, see

last page of this manual. Screw the cap back onto the emptying spout and turn back to its original position.

**Note:** The Emptying Spout Measuring Cap is supplied in the same packaging as this manual.

**WARNING: Never add toilet fluid directly via the blade or the toilet bowl as this could damage the lip seal of the Waste Holding Tank. Always pour the fluids via the emptying spout.**

6. Slide the Waste Holding Tank back into its original position via the access door. Make sure that it is secured with the safety catch. Close the access door and lock it. Your Thetford toilet is now ready to use.

**WARNING: Never use force if you cannot get the tank back into place easily. This may cause serious damage. If blockage occurs, always check if the blade handle is in the correct (closed) position.**

7. For toilets with own Flush-Water Tank: Open the water filling door and fill the flush-water tank with the correct dosage of Aqua Rinse. This Thetford toilet fluid keeps the flush water fresh and improves the flushing. Next, fill up the flush-water tank with clean water (approximately 8 litres) using a ferry can or hose. Your toilet is now ready to use.

### Preparing for use with Optional Features

8. Automatic Ventilator: Open the access door on the outside of your campervan and remove the Waste Holding Tank (as described above).
9. Remove the filter housing cover and if no filter is present, place a new filter into the filter housing. Peel off the sticker lids on the filter. Place back the cover of the filter housing.

### Using the toilet (standard)

10. Turn the bowl to the desired position with the lid closed and using both hands.
11. To activate the control panel, press the flush-button once. The control panel display will stay activated for approximately 5 minutes. Run some

# HOW TO USE YOUR CAMPERVAN'S EQUIPMENT

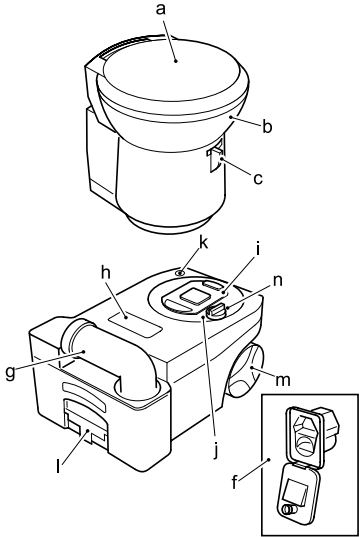
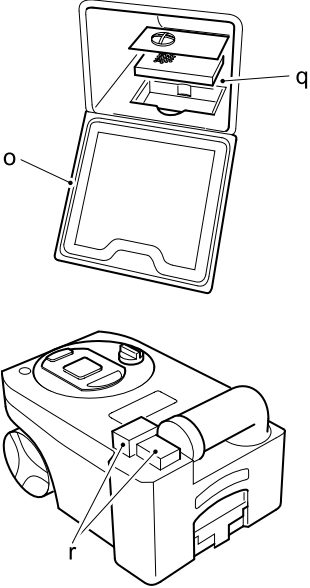
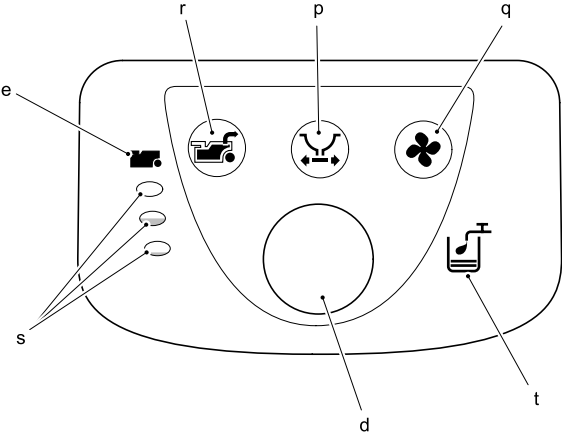
|   |  |
|---|--|
| <p><b>Standard</b></p>                                 | <p><b>Optional features</b></p>  <p><b>Note:</b><br/>Optional features can be bought from Thetford dealerships.</p>   |
| <p><b>Control panel (with optional features)</b></p>  | <p><b>PARTS</b></p> <ul style="list-style-type: none"> <li>a) Removable Seat and Lid</li> <li>b) Swivelling Toilet Bowl</li> <li>c) Blade Handle</li> <li>d) Flush Button</li> <li>e) Waste Holding Tank Level Indicator</li> <li>f) Water Filling Door (only if toilet has own flush-water tank)</li> <li>g) Rotating Emptying Spout</li> <li>h) Automatic Pressure Release Vent</li> <li>i) Sliding Cover</li> <li>j) Removable Mechanism</li> <li>k) Vent Plunger</li> <li>l) Pull-out Handle</li> <li>m) Wheels</li> <li>n) Blade Opener</li> <li>o) Access Door to Waste Holding Tank</li> </ul> <p><b>Optional Features</b></p> <ul style="list-style-type: none"> <li>p) Electric Blade</li> <li>q) Automatic Ventilator</li> <li>r) Waste Pump-Out System</li> <li>s) Waste Holding Tank Multi-Level Indicator</li> <li>t) Flush-Water Tank Level Indicator (only if toilet has its own flush-water tank)</li> </ul> |

# HOW TO USE YOUR CAMPERVAN'S EQUIPMENT

---

water into the bowl by pressing the flush button again briefly.

12. The toilet may be used with the blade open or closed. To open the blade, slide the blade handle under the toilet bowl sideways. After use, open the blade (if still closed) and flush the toilet by pressing the flush button for several seconds (if necessary re-activate the control panel). Close the blade after use.

**WARNING: If your toilet has its own flush-water tank, please make sure that you do not travel with a flush-water tank that is too full. Do not travel with water in the toilet bowl. Failure to adhere to this notice may result in water damage to your campervan.**

## Using the toilet with Optional Features

13. **Electric Blade:** Push the electric blade button on the control display to electrically open or close the blade. In the case of failure, you can manually open or close the blade by sliding the small handle under the toilet bowl sideways.
14. **Automatic Ventilator:** The ventilator automatically starts when the control panel is activated (by pressing the flush button) and will automatically shut off after approximately 5 minutes. The Automatic Ventilator Indicator will flash until automatic shut-off occurs. If you want to stop the ventilator, press the Automatic Ventilator button. If you want to re-start the ventilator, press the button again (the LED will start flashing again).
15. **Flush Water Tank Level Indicator** (only for toilets with own flush-water tank): When the Flush Water Tank Level Indicator lights up, refill the flush-water tank, as only about 1.5 litres of water is left in the tank, which is sufficient for approximately 2 flushes.

## Emptying

The Waste Holding Tank has a capacity of 18 litres and requires emptying when the red light (LED) on the toilet control display lights up, when the Waste Holding Tank only has capacity for approximately 2 more litres,

which is no more than two to three further uses.

Make sure that the blade is closed. Open the access door located outside the vehicle, pull the safety catch upwards and remove the Waste Holding Tank.

16. Place the Waste Holding Tank in an upright position (Pull-Out Handle at the top, Wheels at the bottom). Slide the handle sideways - to the front of the tank - until it snaps out of its locked position.
17. Pull the handle up and wheel the Waste Holding Tank to an authorised waste disposal point.
18. Push the handle back into its locked position. Turn the emptying spout upwards and remove the cap from the spout. Hold the Waste Holding Tank in such a way that during emptying you can operate the vent plunger with your thumb. To empty the tank without splashing, depress the vent plunger while emptying the tank. After emptying, rinse the tank and blade thoroughly with water.

**WARNING: Do not seriously shake the tank or use high pressure water cleaners. This may cause damage to the tank's interior.**

**Note:** The vent plunger should only be depressed once the emptying spout is pointing downwards. Prepare the toilet for re-use if required. Slide the Waste Holding Tank into the toilet and close the access door.

## Emptying with Optional Features

19. **Waste Holding Tank Multi-Level Indicator:** The lower lamp indicates that the Waste Holding Tank is almost empty; the middle lamp indicates that it is more than half full; when the upper lamp lights up, the tank needs emptying as it can only take 2 - 3 further uses.

**Note:** The Waste Holding Tank Level Indicator will flash when the holding tank is not present. In this case the toilet will not flush.

20. **Waste Pump-Out System:** When

# HOW TO USE YOUR CAMPERVAN'S EQUIPMENT

---

activating the control panel this feature automatically lights up. When the Waste Holding Tank Level Indicator illuminates, press the Waste Pump-Out button to pump out the waste from the holding tank into the vehicle's waste tank. The button will flash while the waste is being pumped and will stop automatically (after approximately 5 minutes) when all waste has been transferred. If the vehicle's waste tank is full, the Waste Pump-Out light will flash rapidly and no pump-out will be possible until the central tank is emptied. (Check the level of the vehicle's waste tank on the vehicle's central console). After the Waste Holding Tank has been emptied, there will be approximately 1.5 litres of waste left in the tank. This is normal. Add 2 litres of water and a correct dosage of Thetford toilet fluids to the Waste Holding Tank.

**CAUTION:** It is vital that the correct amount of toilet fluid is added to ensure the proper breakdown of the waste in the holding tank. Only use the system when the tank is full. Using the system too often on an empty tank can cause damage to the pump, which could cause the system to fail.

## Cleaning and Maintenance

The toilet should be cleaned and maintained regularly, depending on the amount of use. To clean Thetford toilets, we advise using water and Thetford Bathroom Cleaner.

**Note:** Never use bleach, vinegar or other powerful household cleaners that contain these substances. These may cause permanent damage to the seals and other toilet components.

## Toilet Bowl

- Squirt Thetford Bathroom Cleaner into the toilet bowl.
- Flush the toilet bowl with water and wipe down the rest of the toilet with a damp cloth.
- Clean seat and lid The seat and lid can easily be removed: Lift the seat and lid assembly and pull the round pins (inside the assembly) outwards from the pin holes. After cleaning, replace the seat and lid by positioning the round pins in front of the pin holes and push the lid and seat downwards.

- To keep your flush water fresh and to prevent deposits from forming in your toilet bowl, add a correct dosage of Aqua Rinse in your flush water tank, if present, on your toilet.

**Tip!** For a really shining toilet, dry with a soft dry cloth after cleaning.

## Waste Holding Tank

To keep your Waste Holding Tank fresh and clean, Thetford has developed a number of different toilet fluids. Thetford toilet fluids suppress smells, reduce formation of gas, promote breakdown of toilet waste and increase the life span of a mobile toilet. We advise a thorough cleaning of the Waste Holding Tank once each season. Next to using Thetford's Cassette Tank Cleaner, the powerful cleaning agent for the periodical cleaning of the Waste Holding Tank of your toilet, we suggest the following: -

- Remove the removable mechanism from the Waste Holding Tank by turning it anti-clockwise and rinse it under a tap.
- Remove the cover plate from the Automatic Pressure Release Vent by prising it up using a small screwdriver. Use one hand to push the Automatic Pressure Release Vent open while holding the float of the Automatic Pressure Release Vent on the inside of the tank with the other hand. Push the float upwards, turn it 180 degrees and remove it from below. Remove the rubber seal underneath the float. Rinse the float and rubber seal under a tap. Replace the rubber seal and float for the Automatic Pressure Release Vent using the same method in reverse.

The rubber seals in the toilet (the lip seal, the mechanism seal, the automatic pressure release vent seal and the cap seal) should be regularly cleaned with water and treated with Thetford High Grade Seal Lubricant. This will ensure that the seals remain flexible and in good condition. If the toilet is not to be used for any length of time, it is important to treat

# HOW TO USE YOUR CAMPERVAN'S EQUIPMENT

---

the seals with Thetford High Grade Seal Lubricant after cleaning.

**Note:** Never use Vaseline or any vegetable oil except olive oil. These may cause leakage or malfunction. The lip seal is a part of the toilet that is subject to wear. Depending upon the extent and manner of use, the seals will become less effective and will need replacing periodically.

## **Cleaning and Maintenance for Optional Features**

- Automatic Ventilation: The filter of the Automatic Ventilation needs to be renewed periodically. After approximately 4 full weeks of use, the filter loses its absorption power.
- Pump-Out Waste System: To ensure optimal functionality of the Pump-Out Waste System, periodical maintenance of the tube and pump is recommended. After emptying the Waste Holding Tank completely, fill it with clean water and empty it again. This will clean the pump and the hose. Do this once every 3 weeks when on holiday. This should ensure proper operation of the system.

## **Winter operation**

You can use your Thetford Cassette Toilet as normal in cold weather as long as the toilet is situated in a heated location. If there is a risk of freezing we advise that the toilet is drained by following the instructions under 'Storage'. For environmental reasons the use of antifreeze, such as that used in car radiators, is not recommended.

## **Storage**

It is important that you follow the instructions below if you do not expect to use your Thetford toilet for a long (winter) period.

- Activate the Control Panel by pressing the flush button. Open the blade and press the flush button until water stops flowing into the bowl. Close the blade. Open the access door on the outside of your campervan and empty the Waste Holding Tank at an authorised waste dump. Follow the instructions for cleaning and maintenance. To allow the Waste

Holding Tank to dry, do not place the cap back on the emptying spout of the tank.

21. If the toilet has its own flush-water tank, place a sufficiently large bowl under the drain tube to catch the remaining water from the flush-water tank and remove the drain plug. When no more water exits, put the drain plug on the drain tube, put it back in its original position and close the access door. If the toilet is connected to the vehicle's water tank, please follow your vehicle's instructions for draining the central water system. If your toilet is optionally featured with a Waste Pump-Out System, take out the Waste Holding Tank and completely clean it (see Cleaning and Maintenance). After cleaning, fill it with water, put it back and empty it via the waste pump-out system. Repeat this twice.

## **Toilet unit malfunctions**

Contact your dealer or a Thetford Service Centre.

We advise draining the fresh water tank prior to travelling. Antifreeze should not be required if the campervan is heated. If you do wish to use antifreeze, brands containing the following properties may be used in the fresh water tank:

- Ethylene glycol
- Mono-Ethylene glycol
- Propane-diol
- Glycerol
- Ethane-diol
- Glycol

Never use alcohol based antifreeze, i.e. Methanol, Ethanol, and Iso-propanol.

# HOW TO USE YOUR CAMPERVAN'S EQUIPMENT

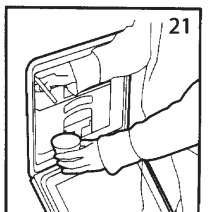
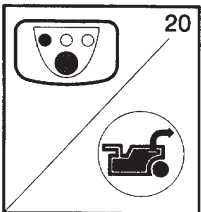
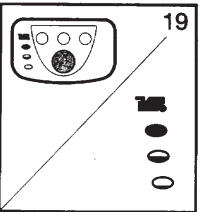
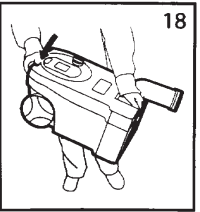
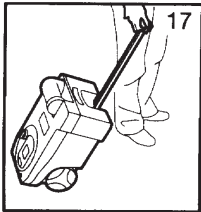
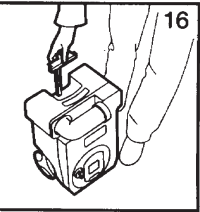
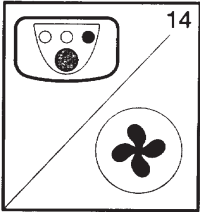
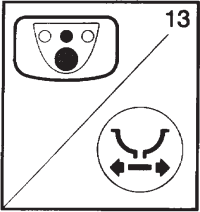
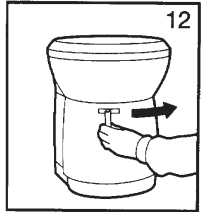
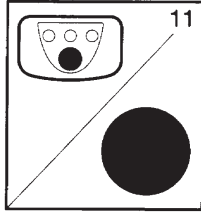
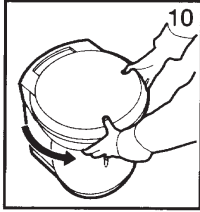
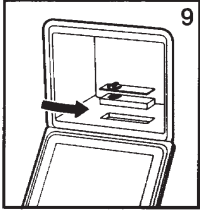
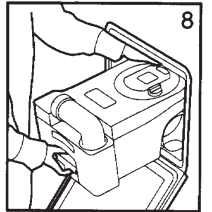
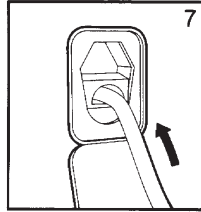
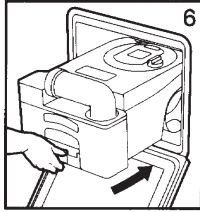
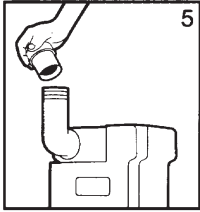
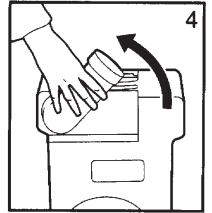
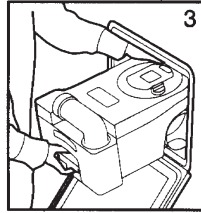
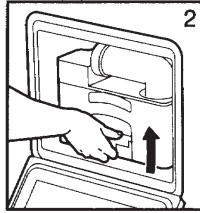
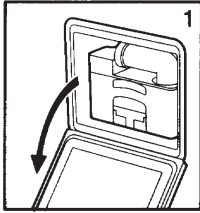

# HOW TO USE YOUR CAMPERVAN'S EQUIPMENT

## HOW TO MAKE UP YOUR BEDS

The double bed is made up by lifting the two side beds up and pulling them together to meet in the centre.

### Campervan Day and Night

DAY POSITION

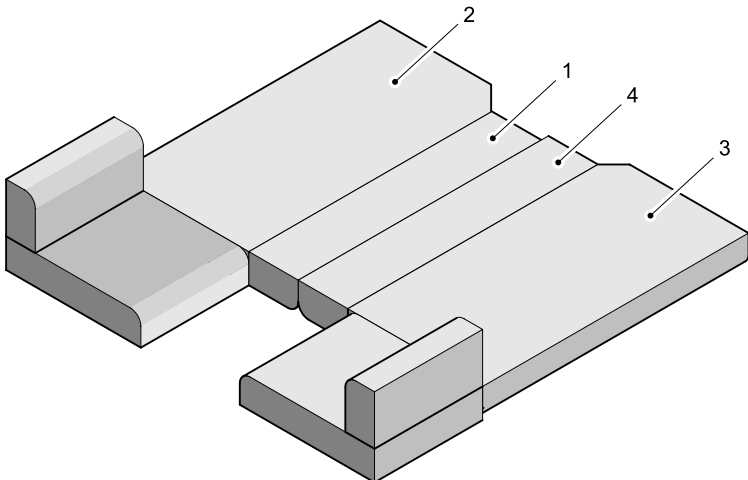
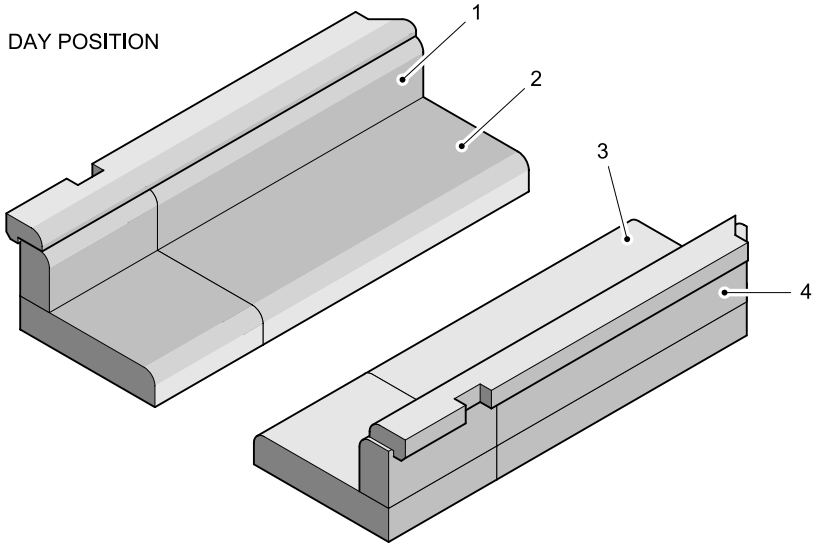

NIGHT POSITION



# HOW TO USE YOUR CAMPERVAN'S EQUIPMENT

## HOW TO MAKE UP YOUR BEDS

### Day & Night - CV40

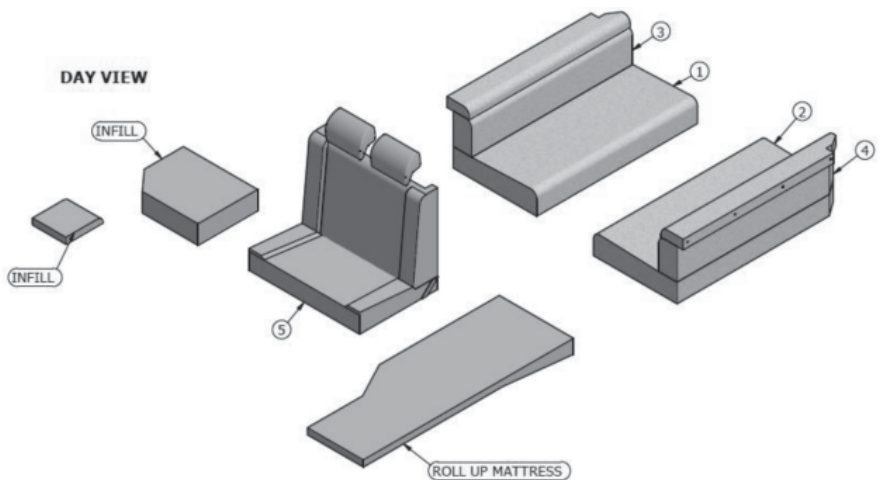

### NIGHT VIEW

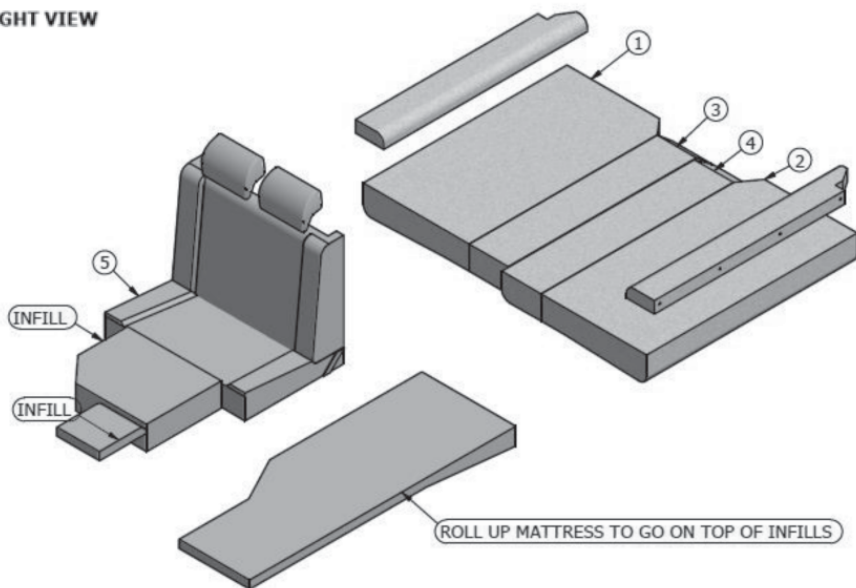

**N.B.** Turn driver seat 90 degrees anti-clockwise to make up front bed

# HOW TO USE YOUR CAMPERVAN'S EQUIPMENT

## HOW TO MAKE UP YOUR BEDS

### Day and Night - CV80

DAY VIEW

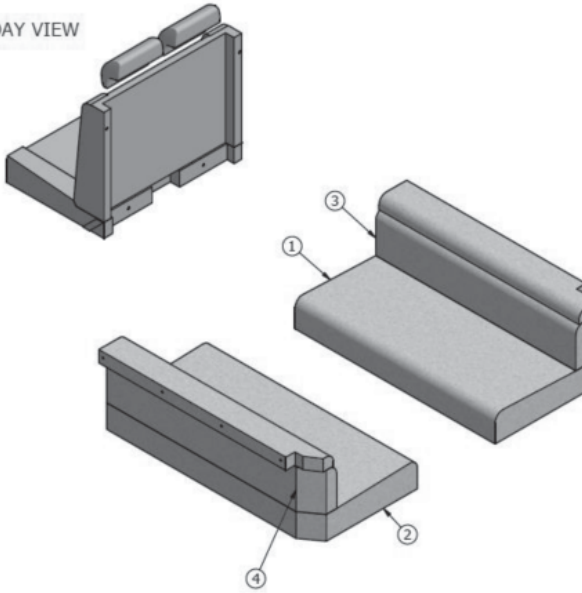

NIGHT VIEW

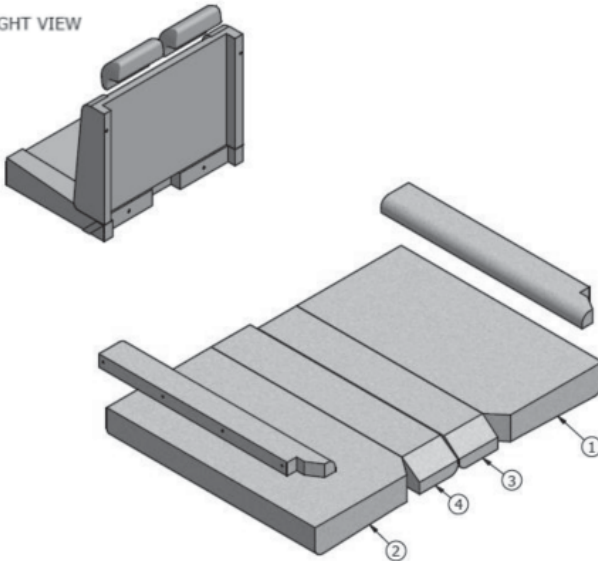

# HOW TO USE YOUR CAMPERVAN'S EQUIPMENT

## How to use your Pop Top - (Where Applicable)

- Danger to life due to lightning.  
Do not sleep in the pop top roof during a thunderstorm. With a lightning strike people in the pop top roof can be fatally injured.  
Do not use your pop top in severe weather conditions.
- Before each journey, check that the pop top roof is fully closed, secured, and locked against automatic opening. An incorrectly closed or unsecured roof could in worse case re-open causing damage during a journey. The top could be torn off and cause severe damage to the vehicle and to third party property.
- Close the pop top roof only when the tent fabric is dry.  
If the roof must be closed with a damp tent fabric the roof should be re-opened as soon as possible so that the tent fabric can dry out.
- Before closing the pop top roof, always close the zips and the velcro straps at the ventilation openings.
- When opening and closing the roof make sure there is a window open or the entrance door is open. This prevents the build-up of air. If there is an air jam, the tent material could be damaged by the mechanics or the roof will not open in the correct manner.
- Make sure that the tent fabric is not trapped between the roof and the vehicle roof when closing.
- If the vehicle is not used for a long period of time:
  - Open every 3 weeks to ventilate well when the vehicle is not in use.
  - Use Dehumidifier (granules).
  - If the humidity in the interior is increased over a long period of time stains and mould can form.
- For additional ventilation, openings in the tent fabric of the roof can be opened by using the zips and velcro.
- When the roof is closed, it is held to the left and right by an additional belt lock.

## Opening The Pop-Top Roof

- Open the belt locks on both sides by pressing the red button.
- Firstly release the electrical locks triggering via buttons:
- Push-button must be pressed for a minimum of 2s so that the locks are unlocked.
  - Time window of 5s, during this time the roof can be opened by hand, use the handles on the roof to push to roof in an upward manner. An additional pole is also supplied to aid the opening of the roof. Use this to push the roof open when you cannot reach by hand.
  - If you do not open the roof within 5s the closures snap back in and will be locked again.
  - Lock the opening when D+ is active (vehicle ignition on).

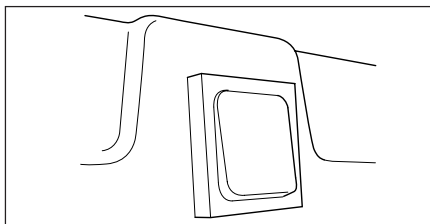

## Signalling Alarm:

- If ignition is active and a lock is open: Alarm beeps every 2s.
- After 30s of the initial alarm: Alarm beeps every 0.5s.
- Signalling is switched off when the ignition becomes inactive again or both locks are closed.
- Push the roof evenly on both handles until it moves upwards on its own.
- When opening and closing the roof make sure there is a window open or the entrance door is open. This prevents the build-up of air. If there is an air jam, the tent material could be damaged by the mechanics, or trapped preventing the roof from opening and closing in the correct manner

# HOW TO USE YOUR CAMPERVAN'S EQUIPMENT

## Emergency Release of Electrical Locks

- Open the zip in the fabric surround at the bottom.
- Pull on both the side cables (red button), located on the locks and push roof slightly upwards until released.

## Wind Protection

The additional straps can be used to provide additional support in stronger winds, with the following procedure:

- Pull out the belts completely
- Hang the locks diagonally
- Fully open the roof
- Tighten straps until they are slightly tensioned

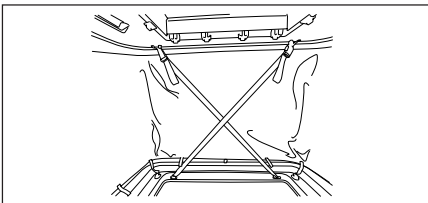

## Ladder

The bed area in the pop top roof is only accessible via the ladder supplied. The ladder is foldable and must be unfolded/extended before use.

### Ladder use:

- Unfold the ladder.
- Hook the ladders into the hanging blocks on the moulding of the pop top roof.
- Turn the 'locking' mechanisms which will secure the ladders in place when in use.
- Reverse the procedure when not in use.
- Store away under the fixed rear bunks to prevent accidental damage or injury whilst the vehicle is in motion.

## Ventilation

When the roof is open, the fabric can be dropped for ventilation.

### Open ventilation:

- Loosen the velcro on the fabric surround, roll up and fasten with the velcro straps.
- A mesh fabric will still be in place as a protection against insects.

### Close ventilation:

- If for any reason the fabric surround has been unzipped around the bottom, zip this back up closing the front centre.
- When closing the zip make sure that the fabric flap that protects the zip does not hang over into the lock receiver bracket.

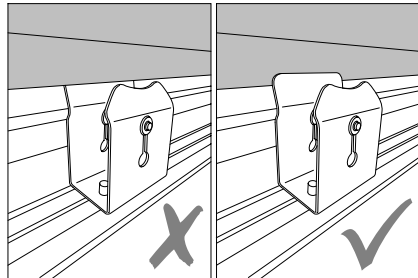

- Loosen the velcro straps, unroll the fabric and push back in place using the velcro.
- In addition, the rooflight permanently fitted in the pop top provides fixed ventilation, this not only provides the pop top with ventilation but also the full vehicle.

## Closing The Pop Top Roof

**WARNING: It is important to ensure that no items (including bed covers, pillows and cushions) are stored inside Pop Top bed area when closing.**

**Items left in-situ can compromise the closing of the roof and may result in damage of the fabric surround and/or roof mechanisms.**

- Slowly pull down the roof using the fabric belt provided so the roof remains independently in this position. In doing so, ensure that the left and right sides of the roof are led down parallel.

**CAUTION** – Please ensure hands are clear of the closing areas.

# HOW TO USE YOUR CAMPERVAN'S EQUIPMENT

---

- The fabric surround will fold. Ensure the tent fabric is not trapped between the pop top roof and the vehicle roof when closing.
- If the fabric is not pulled inwards then the roof should be reopened and closed slower.
- With the roof half closed, pull the tent fabric inwards using the tabs.
- Pull down on both sides using the handle until the lateral locks snap in place.
- Maintain control of the roof throughout the closing process using the handles provided.
- **CAUTION:** the final part of the closing the roof will shut with significant force due to the weight of the pop top roof unless suitably controlled.
- Click the two parts of the fastening strap together.
- Tighten the straps once clicked together.

## **Fall Protection**

Please ensure the net protection provided is always in use when using the pop top bunk area.

Pull the net from under the mattress and attach it to the brackets provided. Ensure the net is firmly in position and cannot accidentally be moved from that position.

## **Additional Safety Advice**

Children from 0-6 years old are only allowed to use the roof under supervision.

# HOW TO USE YOUR CAMPERVAN'S EQUIPMENT

## WING OMNI-DIRECTIONAL TV ANTENNA

### Operating Instructions

- 1) Switch on the amplifier using the on/off switch.
- 2) Turn the dB dial of the amplifier clockwise to increase the gain of the TV signal received.
- 3) Tune your television to a channel available in the area where you are located.

### Changing the slant of the antenna

Should the roof of the vehicle not be flat, we suggest you change the slant of the antenna so that it is parallel to the ground when installed. In fact, in order to give its best performance, the antenna must be:

- 1) Far from any obstacles which can hinder the passage of TV signals (for example trunk holders, air conditioners, etc.)
- 2) In a horizontal position. One should also bear in mind that TV signals diminish considerably beneath trees and reception can be poor or even non-existent.

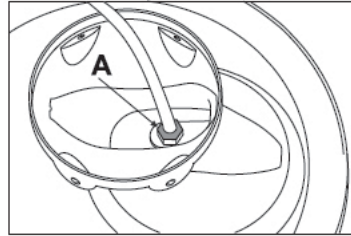

Loosen the nut (A) slightly (by one quarter of a turn).

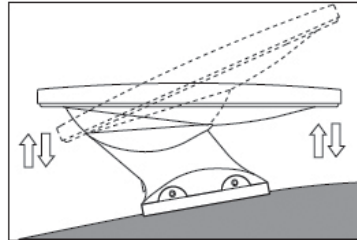

Mount the antenna on the roof and slant it until it becomes horizontal. Tighten the screws (A) again and fasten the antenna to the base.

## Wiring connections

**Band: 40-780 MHz**

**Max. Gain FM + DAB 25 dB/UHF 25 dB**

**Power supply: 12-24 Vdc**

- 1) Cut the antenna cable to the proper length and apply the connector. Make sure no wire of the braiding touches the core of the cable.
- 2) Fit the antenna connector into the relevant input of the amplifier and then connect the TV sets using two pieces of cable.
- 3) Connect the AT 412 LTE to a 12 (or 24) Volt battery. Make sure you do not mix up the + and - clamps.
- 4) Look at the TV set and adjust the sensitivity of the antenna by turning the "dB+" handle until you get the best image.

If the amplifier is connected to the battery, this switch allows to cut off the power

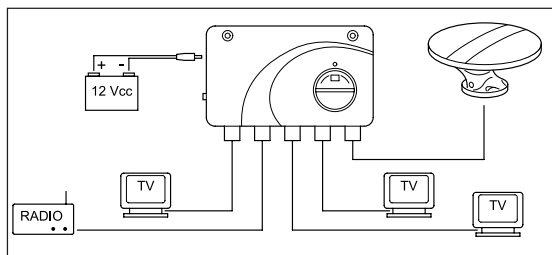
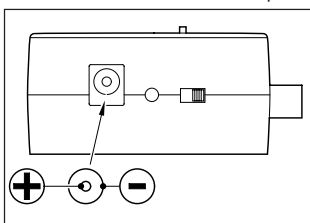

# HOW TO USE YOUR CAMPERVAN'S EQUIPMENT

---

## THULE STEP

Read this installation instruction and the safety instructions in appendix thoroughly. No guarantee will be allowed for damages caused by wrong installation or operation.

### Operation

- The Thule Step is operated by the lever switch.
- Maximum static load is 200kg.  
**Note:** Hold the switch until the step is fully extended.
- Never use the step when retracted or not fully extended, or the blocking will not work and the motor can be damaged.
- Always check that the step is fully retracted before departure.

### Safety instructions

Read this safety instructions thoroughly, before starting up the device and store it in a safe place. If the device is handed over to another person, this manual is to be handed over along with it.

**CAUTION:** Safety Instruction: failure to observe this instruction can cause material damage or personal injury and impair the proper functioning of the device.

**CAUTION:** Safety Instruction relating to danger emanating from electrical currents or voltage: failure to observe this instruction can cause material damage or personal injury and impair the proper functioning of the device.

The manufacturer will not be held liable for claims for damage resulting from the following:

- Faulty assembly or connection
- Damage to the appliance resulting from mechanical influences and excess voltage
- Alterations to the device without express permission from the manufacturer
- Use for purposes other than those described in the operating manual

**WARNING: To prevent short circuits, always disconnect the negative terminal of the electrical system before working on the vehicle. If the vehicle has an additional battery, its negative terminal should also be disconnected.**

**WARNING: Inadequate supply cable connections could result in short circuits with the consequence that:**

- **cable fires occur**
- **the airbag is triggered**
- **electronic control devices are damaged**
- **electric functions fail (indicators, brake light, horn, ignition, lights)**

**CAUTION:** Installing the wrong fuse can cause cable fire in case of a short circuit or malfunction!

### Maintenance

Dirt and frost can prevent the Thule Step from operating properly. In this case the moving parts should be cleaned or defrosted. Keep the footboard clean and check the operation of the switch regularly.

It's possible to take out the footboard in order to clean the step inside.

- Retract the footboard by the lever switch, when possible not fully. Disconnect the power to the step.
- Disconnect the 2 drive rods from the footboard by removing the clips at the bottomside of the footboard.
- Take away the 2 black stops with the screws at the outside.
- Take out the footboard and clean.
- Brush the inside of the step and remove the dirt with a vacuum cleaner. Never use a high pressure cleaner or water.
- First reconnect the driving rods. Followed by fixing the endstops.

### In case of electrical failure

If the step does not retract by motor: it's possible to take out the footboard: see maintenance. **Note:** Never retract or extend the step by hand without this mechanical disconnection.

### Current drawn

The Thule Step motor uses 2A during operation. **Note:** If the switch is kept pushed when fully extended or retracted, it uses 9A.

### Accessories

- Electronic control unit (308812) for automatic extension and extraction when opening or closing the door.
- Relay for automatic retraction (x10) (308200) that prevents operation of the Thule Step and keeps it retracted whilst driving.

# HOW TO USE YOUR CAMPERVAN'S EQUIPMENT

## Whale Easi-Slide Socket

How to open the socket lid

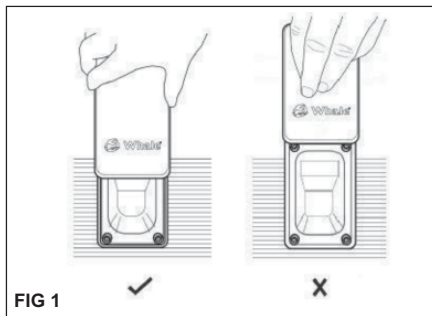

FIG 1

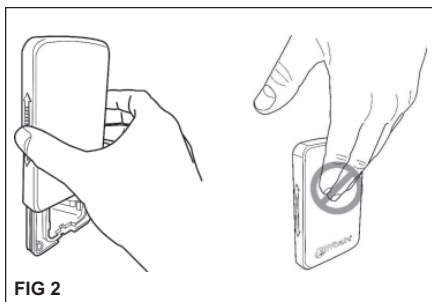

FIG 2

## Safety Information

This appliance is **not** intended for use by persons (including children) with reduced physical, sensory or mental capabilities, or lack of experience and knowledge, unless they have been given supervision or instruction concerning use of the appliance by a person responsible for their safety.

- Children **must be** supervised to ensure that they do not play with the appliance.
- Any alteration to the appliance, misuse or use of non-original Whale parts may invalidate the warranty. Non observation of the installation and operating instructions will lead to cancellation of the warranty and exclusion of liability claims. It also becomes illegal to use the appliance if incorrectly installed, and in some countries may make it illegal to use the vehicle.

## Additional Safety Information for Main In, Mains Out and Multimedia 3 in 1 Sockets (Where Applicable)

All work must be carried out by a competent person as defined by BS7671 Part 2/IEC 60364.

## Safety

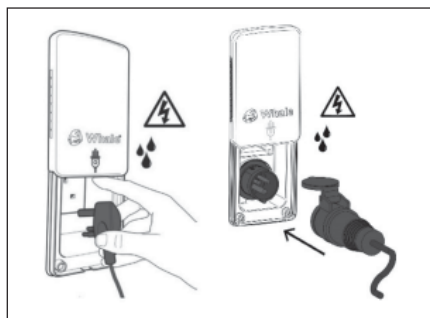

- If the mains in or out supply cord is damaged, it must be replaced by a special cord or assembly available from the manufacturer or its service agent.
- For use in recreational vehicles only.

## Additional Safety Information for Onboard Tank Fill, On Board Tank Fill +12v and Water In / Out Sockets ( Where Applicable)

- For use in recreational vehicles with a typical water system pressurised up to 3 bar.
- When using the **Water In Socket**, Whale recommends that you keep the o-rings lubricated for easy and secure connection/removal of the plug to socket. Use a water-based lubricant such as silicone grease. **Please note: Do not use vaseline or vegetable oil to lubricate o-rings.**



# HOW TO USE YOUR CAMPERVAN'S EQUIPMENT

## Mobile Internet (Option)

If this option is applicable, your router has already been installed in the optimum position within your vehicle. The location of the internal router may vary depending on vehicle layout. The information below outlines the basic setup and how to get online. For more detailed information, please refer to the manufacturers operating instructions supplied with your vehicle.

### Get to know your Router

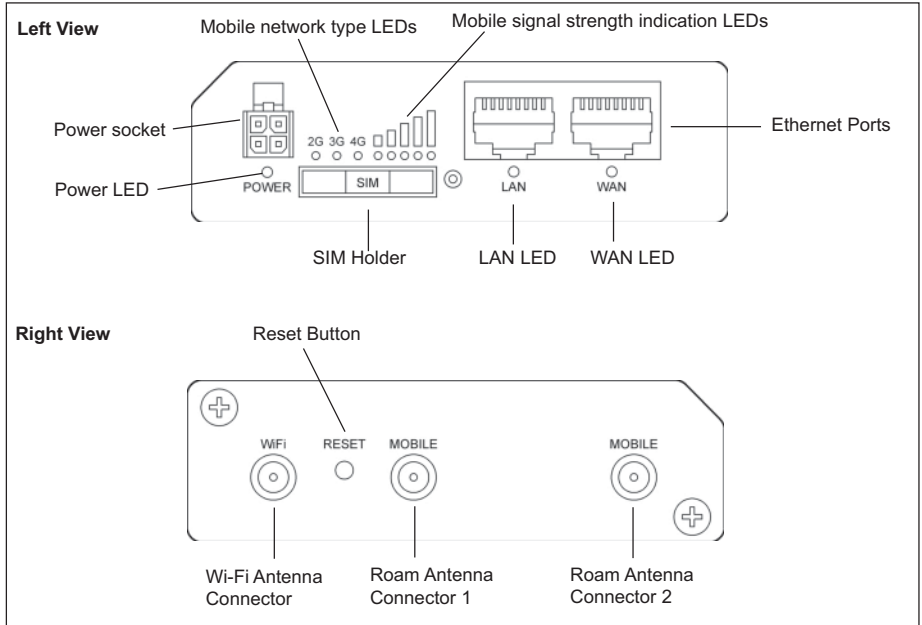

### Credential Router Sticker (located on the reverse of the Router)

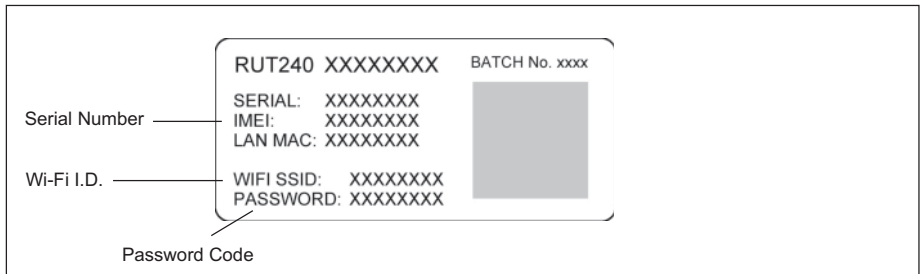

# HOW TO USE YOUR CAMPERVAN'S EQUIPMENT

## Getting Online

Now your Roam is installed and you have inserted the SIM card, its time to get connected. To do this, you will need to be using a device which can connect to a Wi-Fi network such as a smart phone, Smart TV, tablet or laptop.

1. Turn on router and allow 2 to 3 minutes for the router to boot.

When ready, the router name will be visible in your devices Wi-Fi settings.

## Device Settings

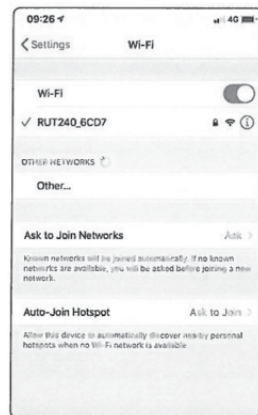
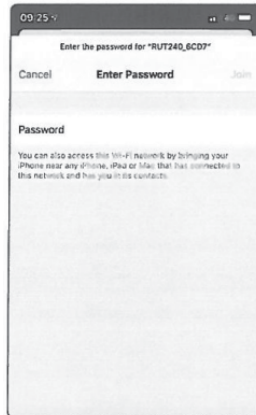
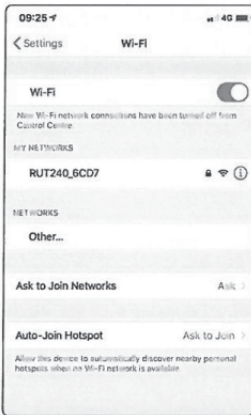

1. Navigate to your devices Wi-Fi settings and view available Wi-Fi networks.
2. The Roam router will be displayed as RUT240\_XXXX. The last 4 characters will be unique to your Roam router.

If more than one Roam is being used within close proximity, the Wi-Fi network name is displayed on the back of the router.

3. Once you select this network, you must enter the password. This is also printed on the back of the router.

**Note:** Password is case sensitive

4. You are now connected and can begin using your Roam.

# HOW TO USE YOUR CAMPERVAN'S EQUIPMENT

## Factory Reset

At any time, the Roam router can be reset to its factory settings using the reset button on the side of the router. This will restore all settings on the router, including:

- Router SSID (network name) and password to those listed on the back of the router.

- Web User Interface to the username and password listed on the front of the router.
- All custom settings will be deleted, including any Wi-Fi connections you may have added.

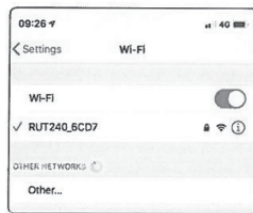
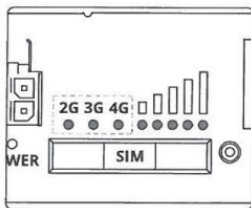
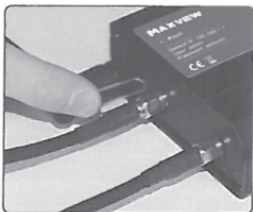

1. To complete the factory reset, press and hold down the reset button with the supplied pin needle.
2. Hold for 6 seconds, until all of the green LEDs on the side of the router are on.  
Once released all 5 signal strength LEDs will flash together.  
This indicates the start of the reset process.  
**Note:** If you don't hold long enough, the router will restart but not reset.
3. Allow 3 minutes for the router to reset. Once reset the Wi-Fi network will be visible and available to connect to.



## SECURITY

Theft deterrent, prevention and security of your campervan is taken very seriously at Erwin Hymer Group UK. That is why we have provided a combination of standard features and optional extras designed to deter and prevent thieves from stealing your property. And in the unlikely event that they should succeed, aid the identification, speedy recovery of your property and assist in the prosecution of the thief.

### Tracker (Option)

Your campervan can be fitted with an optional TRACKER.

Your dealer may have registered the campervan with TRACKER and confirmation sent to you via email.

If it has not been registered you can easily do it yourself.

Open the TRACKER registration portal  
[www.tracker.co.uk/elddis](http://www.tracker.co.uk/elddis)

TRACKER VLU and Campervan VIN

Numbers are matched and confirmed with the vehicle model

Enter Dealership name from dropdown menu

Enter customer details including email address

Confirmation sent to customer email

One year subscription will begin

TRACKER will contact customer towards the end of the one year subscription period with the options available.

or call TRACKER directly on 0870 606 1269

### Campervan Theft

The theft of a campervan can occur in the most unlikely circumstances; from a motorway service area, even from an owner's driveway. Secure all windows and doors when your campervan is unoccupied, even if only for a short length of time.

### VIN CHIP

VIN CHIP is the theft deterrent and identification system for touring caravans, motorhomes and campervans. VIN CHIP has been launched to deter criminals looking to steal your vehicle and help aid the identification and recovery. VIN CHIP is unique as it uses both visible and invisible markings containing a specific 17 digit VIN.

### Alarm (option)

Your vehicle can be fitted with an optional Autowatch 695 Thatcham Category 2-1 alarm.

### Electronic Alarm (Category 2-1)

A Thatcham assessed 2-1 Electronic Alarm is to be combined on a vehicle installed with an existing Thatcham Category 2 immobilisation system to obtain a Thatcham Category 1 status.

### Alarm

The Alarm is to provide warning of an attempted of intrusion into the passenger compartment or unauthorised interference with a vehicle.

- Perimeter detection
- Ignition detection
- Passenger compartment movement detection
- Audible warning with battery back-up power supply
- Siren Resistance to attack for a minimum duration of 1 minute



## CARE OF YOUR CAMPERVAN

This section of the guide is devoted to the care, cleaning and general preservation of your campervan in order to retain its showroom condition.

For care of the base vehicle please refer to the original manufacturers handbook provided with your campervan for more information.

### Exterior Body Shell

The exterior painted body shell of your campervan, is extremely durable and easy to clean. It is recommended you first wash off any embedded dirt and mud with cold water then use Autoglym products.

**CAUTION:** Under no circumstances should an abrasive or harsh cleaner be used. Do not use a pressure washer as this can disturb bonding agent.

### Acrylic Windows

Your campervan is fitted with shatter resistant acrylic windows. To preserve their clarity and unblemished transparency it is essential that the following cleaning instructions are strictly adhered to: Road grit, dust, sand, flies, bird droppings etc., should be washed off using plenty of cold water do not use a sponge to clean off heavy dirt deposits. Any remaining dirt should be washed off using a soft cloth and warm water. Under NO circumstances should any abrasive cleaning agents, household detergents or proprietary cleaning fluids be used. Wash the window again using only cold water and dry off with chamois leather.

**Please note:** Should scratches appear on the acrylic windows these can often be removed with an acrylic polish. E.g. ICI Perspex polish. Gentle polishing with a liquid metal polish, i.e. Brasso may also have the desired effect - consult your retailer BEFORE attempting to remove any but the slightest scratch.

### Window Blinds & Flyscreens

To clean the blinds and flyscreens, moisten a soft cloth or sponge with a small amount of water and mild soap suds and gently wipe dirt off. Allow to dry before retracting, failure to do this could result in mildew forming.

### ABS - Components

To preserve the appearance of all ABS panels and fittings road grit, dust, sand, flies, bird

droppings etc., should be washed off using plenty of cold water. Any remaining dirt should be washed off using a soft cloth and warm water. Under NO circumstances should any abrasive cleaning agents, household detergents or proprietary cleaning fluids be used. Wash the ABS material again using only cold water and dry off.

### Interior Walls

Your campervan interior walls will only require a wipe over with a damp cloth, using soap and water to keep them in a 'showroom' condition.

### Furniture

Treat your campervan furniture as you would the furniture in your home. Polish wood surfaces sparingly with a good quality wax or spray polish. Use a damp cloth to clean Melanate laminated surfaces.

### Taking care of your upholstery:

You may find your upholstery a little firm at first, this is perfectly normal as all foam and filling composites will naturally soften in time. This softening does not constitute as a fault under the warranty. Fabrics with a pile may appear to have a difference in shades, this is due to the direction of the pile and how the light reflects. This is not a fault but a part of the charm of the fabrics. Regular care with a soft brush will ease the pile back and reduce the effect of the pile being flattened over time. Fabric will stretch, move and develop creases or wrinkles during use, these are expected and are completely normal during the lifetime of the product. It is important that all cushions and upholstery are regularly "dressed". To do this, the cushions and upholstery require 'plumping' to ensure they revert to their original shape. Without "dressing" and "smoothing" the cushions it could give the appearance of flat or miss shaped, making the fabric appear loose or baggy. This is not a defect but part of the care of the product/s. Please ensure all cushions/ upholstery are always placed in the correct position during use. It is recommended that the curtains in your leisure vehicle are washed on a delicate cycle at 30°C. This will not damage the clip glides. Shrinkage may be caused should you decide to dry clean your curtains.

**Note:** Curtains should not be left closed during daytime hours otherwise some fading may occur.

## Taking care of your carpets:

Soiling (dirt, dust and abrasive matter) is the greatest threat to carpet. Door mats should be cleaned frequently to prevent them from becoming a source of soiling. The best way to increase the life of your carpet is to vacuum regularly. For general cleaning use a dry shampoo following the products instructions. Spills are likely to happen and if you treat spots and stains immediately, they will be easier to remove. Blot liquids with a dry, white, absorbent cloth or plain white paper towel. To prevent the spill from spreading, please work from the edge of the spot to the centre. For food and other non-liquids, start by gently scraping up with a spoon or knife blade and vacuum until completely removed.

**Note:** Do not get the carpet too wet. Wetting through to the backing may result in shrinkage, discoloration, odour and delaminating. Certain products can cause irreparable damage to your carpet. Bleaches, tile cleaners, mildew removers, oven cleaners, etc can have strong chemicals which discolour or dissolve carpet fibres.

## Washroom And Handbasin Fittings

These should be cleaned using a non abrasive household cleaner. Always put the cold water into the hand basin before adding the hot in order to preserve the finish of the thermoplastic formed basin.

**Please note:** Under no circumstances should alcohol, spirit or solvent-based liquids be used on GRP or ABS plastic panels as these substances may react with the material and cause visible damage.

Cleaning instructions for all chrome plated products – (taps, wastes, bathroom accessories, etc.)

Alcohol, solvents and solid detergents, liquids containing acid or aggressive solutions, anti-calcareous products, abrasive sponges or steel wool should absolutely be avoided since they could corrode in an irreparable way the outer surface of the products.

## Shower Trays

Only clean your shower tray using soap and water. Do not use chemical based cleaning agents as this may attack the material of the tray.

## Water Systems

The water systems and in particular storage tanks, in campervans are susceptible to contamination by bacteria if care is not taken with their use and cleaning. The symptoms caused by bacterial contamination are not purely limited to gastro-intestinal diseases, but may also manifest themselves as ear, nose, throat, and eye or skin infections. It is therefore important that you carry out the following procedure prior to using the campervan each time, even if you boil or filter all water you use for drinking.

**Please note:** If your campervan is not going to be used for an extended period of time please refer to section 12-1 Storage.

## Water Containers

- (i) All water remaining in any water container should be disposed of so that the container is empty.
- (ii) The outside of external water containers should be thoroughly cleansed and washed down to remove any dirt, dust or other contaminant. Water at a suitably hot temperature containing an appropriate detergent is recommended for this purpose.
- (iii) All containers should then be totally filled with water containing an appropriate disinfectant / sterilising solution and allowed to stand for the recommended contact time.
- (iv) The solution should be emptied from the container.
- (v) External containers should be inverted whilst stored overnight (if possible).
- (vi) Containers must be filled with mains water only and mains water only should be used for the above cleaning procedure.
- (vii) On no account should garden hoses be used to fill water tanks.



## Internal Water Systems

- (i) Drain down the system. (Open all taps to allow air in, enabling the system to drain quickly).
- (ii) Fill the system by using the pump with a disinfectant / sterilising solution. (Check that the solution at full strength appears at all taps/showers). Allow to stand for the recommended period of time.
- (iii) Drain the system down completely.
- (iv) Thoroughly clean the outside of all taps/connectors with a cloth soaked in the disinfectant / sterilising solution.
- (v) Flush the system through with clean drinking water until no traces of disinfectant / sterilising solution can be detected at any tap.
- (vi) Sterilising chemicals are available from your Erwin Hymer Group UK Retailer, accessory shop, chemists, or homebrew shops. It is not, however, recommended to use bleach or sodium metabisulphite.

## Thetford Toilet

### WARNINGS

**Cold Weather Use - To prevent freezing during cold weather use, add antifreeze to the toilet system fresh water tank. Use a non-toxic (propylene glycol) type of antifreeze. Refer to chart on container to obtain level of protection.**

**The C60 toilet does not have its own fresh water tank and only operates from the fresh water supply so it is not possible to add antifreeze or Thetford chemicals.**

**Warmer Weather Use - In warmer weather or longer intervals between emptying the waste tank you may require additional toilet fluid. Use only Thetford toilet fluid to achieve the best results.**

### CAUTIONS

- Do not use strong household detergents or cleaners that contain chlorine, solvents or acid contents.
- High Altitude and Hot Weather Use - with large temperature differences and changing heights during driving,

pressure can start to build up in the waste holding tank, causing contents to splash upward upon opening the valve blade if opened too fast.

## Changing a Wheel

Refer to the original manufacturer handbook provided.

## Tyres & Tyre Pressures

Please refer to the Technical Specifications pack that is provided with the vehicle for information regarding tyre pressures and tyre sizes. It is dangerous to drive with under inflated tyres. Pressure checks, including those on the spare tyre, should be carried out whilst the tyres are cold using an accurate pressure gauge. These checks should be carried out before each journey and at regular intervals during storage.

## Tyre Wear and Damage

Your vehicle tyres, like all tyres, are legally required to have a minimum tread depth. Please refer to the original manufacturer's handbook provided. A redundant tyre must be replaced by one of the same size and load index. A tyre should be renewed if a blister, rupture or cut exposing the casing is detected. If the tyre has suffered a violent impact, it should be examined by a specialist as soon as possible.

## PRE-SEASON WATER SYSTEM PREPARATION

Over the winter months bacteria can grow in your water system. Particles of minerals and dirt gather in joins and any undrained areas. After following this guide, change your water filter. If you have a Whale AquaSmart system, change your Whale WF3000 Water Filter. If you have an in line filter in your plumbing system, Whale recommend you use WF1230 Aquasource Water Filter.

To check the system hasn't suffered any frost damage over the winter and floods your van, take the following precautions:

- Close all drain valves in your van's water system.
  - Re-attach your shower head.
  - Ensure all taps and showers are positioned over sinks and drains.
  - Check condition of leisure battery, if it is below 12V please connect to mains electricity supply.
  - Rinse out fresh and waste water tanks with water, add a non-caustic cleaning and purifying agent.
  - Completely fill your fresh water tank with tap water.
  - Leave the hot tap that is furthest away from the water heater fully open, close all remaining taps and showers.
  - Turn on isolation switch for water pump, normally found on the control panel or in a menu within the control panel's software.
  - You should hear the pump running or the pressure coming from the open hot tap.
  - Water will pop and splash as it comes from the hot tap, it will take some time for a flow of water to arrive as the water heater needs to fill up first.
  - Once an even flow is achieved, work back towards the water heater, opening the next further away hot tap until all have been opened and there is a smooth water flow.
  - The next stage is to close all hot water taps and open the cold water taps in the same order as the hot taps, beginning at the furthest away cold tap.
  - When an even flow is achieved through all the taps in your van close all the taps. The pump should turn off (after a few seconds if it is a pressurised system).
- Remain in your van after the pump has stopped and inspect all the taps and shower heads for leaks. You may need to dry them down first to spot any leaks). If there is access to the underside of the taps check for water leaks.

If you find a water leak, check the following:

- If there is a water leak coming from the connections on the underside of the tap, try to push them home.
- If the leak originates from a crack or an unknown source check the rest of the taps and showers before turning off the water pump.
- Then drain the water system as the water pressure will continue to escape through the leak and will cause water damage to your van. Contact your local dealer to rectify the leak(s).

**(Note:** While checking the taps and showers you may hear the pump turn on and off a few times. If you hear this, turn on and off all the taps for 10 seconds individually to remove any trapped air from the system.)

- If the pump continues to run intermittently for short bursts this can indicate a leak as pressure is being lost. Follow all the water pipes and check if there is any water leaking from joints or if a pipe is burst.
- Should you find a leak at a joint, tighten the joint or push the pipe fully into the Quicklift fitting to dry up the water and wait to see if the problem persists.
- If you find a burst pipe or damaged tap/shower we recommend that you contact your nearest Campervan dealer.
- After the cleaning agent has remained in the system for the required time, purge the system by running 2 or 3 full tanks of water through the system using all taps and showers in the mixed position.
- Check the strainer on the pump.
- Finally your system is ready for use.

If you have successfully carried out this guide, please check your water heater is functioning correctly, to do this please follow the manufacturer's instructions.

**Enjoy the new season.**

## GETTING READY FOR THE WINTER

If possible carry out the following procedure prior to moving your vehicle to its winter storage location. The movement of the vehicle will encourage residual water to naturally drain from the system.

Ensuring that all water is removed from the vehicle's pipework, taps and appliances will reduce the risk of frost damage occurring. Frost damage occurs when water left in the system freezes and expands, causing pipework and appliances to split, crack or burst.

- Open water heater drain valve and leave open.
- Open external tank valve (if present) and leave open.
- Ideally, position motorhome so the drain taps are at the lowest point i.e. tilt the motorhome or park on a slope.
- Ensure the gas is turned off at the mains.
- Open all taps/mixers to the mid position, including the external shower (if fitted).
- If internal pump is accessible, disconnect outlet pipe and turn on pump, allow to run for 2 minutes to expel additional water into an adequate basin, turn the pump off. Only reconnect pump when water system is to be used.
- Remove shower head and hose (including the external shower, if fitted) and shake water out.
- Waste tank - remove all sink plugs, open drain taps and leave open.
- Open any other drain points (if present).
- Drain all external water components.
- Fully drain/empty holding tank and flush toilet tank in accordance with the manufacturer's instructions.
- Do not close the fridge door, leave ajar to allow air flow to prevent mildew.

**User tip:** If mains electric hook up is available and a Whale Space Heater is fitted, select 500w electric and set temperature to frost protection.

**User tip:** To maintain the battery, periodically charge throughout the winter. Do not allow the leisure battery to fully discharge as this could cause irreversible damage.

**Whale Customer Support:**  
Tel: +44 (0)28 9127 0531  
Fax: +44 (0)28 9146 6421  
Email: [info@whalepumps.com](mailto:info@whalepumps.com)  
[www.whalepumps.com](http://www.whalepumps.com)

## 1. Pop Top Tent Fabric

The Pop Top Tent fabric has water repellent properties, however, it is not waterproof.

Care:

- Clean dirt with a soft brush at regular intervals when dry.
- Small dirt can be carefully removed by rinsing with warm water (max. 35°C) (Do not use high pressure cleaners).
- After cleaning, allow the tent fabric to fully dry, preferably in sunlight.
- For larger dirt and stains, clean only with a mild soap solution at approx. 35°C, rinse well to remove any soap residue.

## 2. Cleaning recommendation of the Outer Shell

This cleaning guide must be followed to maintain the lifespan of the product.

### 2.1 Cleaning recommendations

Regular cleaning must be carried out to maintain the lifespan of the product. The outer surfaces should be cleaned by hand using cold water to remove any embedded dirt, then use Autoglym products in accordance with the manufacturers recommendations.

All heavily soiled areas of grease or oil smeared surfaces should be washed or wiped off immediately. Drying can be done naturally or with a soft clean cloth.

### 2.2 General Cleaning

Do not use a pressure washer on your vehicle as it can lead to water entering via any of the external vents and could cause damage to the graphics. NO mechanical cleaning aids should be used i.e rotating brushes, scrapers or similar cleaning devices as they will scratch the outer surface of the product. Under NO circumstances should an abrasive or harsh cleaner be used. The use of tree resin remover should be avoided, cleaning agents of this type can lead to stress cracks in the product.

**User Tip:** In general, cleaning agents should be removed from the surface to avoid lasting damage.

## STORAGE

### LONG TERM & WINTER STORAGE

If your campervan is to be stored for any length of time, especially over the winter period, the following operations are recommended:

- (i) Ensure all windows, roof lights, habitation and exterior locker doors are closed firmly and locked.
- (ii) Remove all soft furnishings which could be affected by damp conditions
- (iii) Clean the campervan inside and out.
- (iv) Drain the water system.
- (v) For winter storage and to prevent frost damage all taps must be left in the open position. For those campervans with lever taps please ensure the taps are left in the central position.
- (vi) All blinds and flyscreens should be left in the retracted position. Check all fixed ventilation apertures are not obstructed.
- (vii) Ensure that the refrigerator/freezer compartment doors are left open during storage.
- (viii) Check that the site you have chosen to store the campervan is open, fairly high and dry and if possible not exposed to gales etc.
- (ix) It is recommended that you use a suitable dehumidifier or place a bowl of salt within your campervan to absorb any moisture during the winter months.

### Campervan Covers

Covers may be used to protect your new campervan provided that the cover used is of a breathable type.

Lower the TV antenna and ensure the cover is well tied down to avoid the cover being punctured.

Your campervan must be ventilated every 4 to 6 weeks if it is to be stored with a cover in place.

## Battery Maintenance

### Storage

Ensure that the leisure battery is fully charged before placing the vehicle into storage.

Check the battery state every month, if the terminal voltage drops below 12.07V then re-charging is necessary.

Charging should be carried out in a cool, dry well ventilated area.

Do not place the battery onto cold surfaces such as concrete as this will affect the battery's ability to charge.

Should the campervan be stored for a prolonged period of time it is strongly recommended that the campervan is fully serviced before the commencement of use. Your retailer will ensure that your campervan is safe, secure and ready for your enjoyment.



## **CAMPERVAN HABITATION WARRANTY COVER**

### **Introduction**

At Erwin Hymer Group UK we are confident that our new campervans are engineered using the latest manufacturing techniques and advanced materials technology ensuring that, when buying one of our products, you are buying the very best. We extend this philosophy to our customers by offering long term peace of mind and reassurance through our extensive warranty cover.

Your warranty cover commences on the day your new campervan is purchased and comprises of three key elements:

1. The base vehicle warranty cover is provided by the original manufacturer. Please contact your local base vehicle retailer direct for any base vehicle warranty issues.
2. Three year Erwin Hymer Group UK manufacturer's warranty
3. Ten year Erwin Hymer Group UK body integrity warranty

### **Scope**

This applies to all new products and is a guide intended to give a brief overview of the warranty terms applicable to your vehicle.

### **Conditions of use**

Your new campervan has been designed as a leisure vehicle only. The warranty will not be given if the vehicle is used under the following circumstances.

- Used for hire
- Used as a permanent residence
- Used for racing or time trials
- Damage resulting from freezing, accident or fire damage

### **Exclusions**

- No liability will be accepted for fair wear and tear, including mould or discolouration of adhesive. Damage including rodent damage, wilful damage or negligence from abnormal working conditions will not be covered.
- Condensation is not covered under the warranty agreement.

### **Three year manufacturer's warranty**

**Year 1 warranty** - Covers all original components, forming part of the original product specification excluding normal wear and tear.

**Year 2 and 3 warranty** – Covers all original components, forming part of the original product specification, excluding the following items:

- Normal wear and tear
- Microwaves
- Batteries
- Windows and glass
- All soft furnishings including mattresses (2-year warranty cover)
- Entertainment equipment
- LED lights
- All plastic products
- Adjustments
- Ironmongery and corrosion of metallic components
- Electrical connections
- Floor coverings

We would recommend that customers have their vehicle serviced on or before the due date to ensure that all warrantable parts are identified before the expiry of the component.

### **Ten year body integrity warranty**

Erwin Hymer Group UK products are covered against water ingress for 10 years from the original date of purchase of a new product. (Reduced to 6 years for subsequent owners from 1st owners original date of purchase). Covering any water ingress as a result of a warrantable defect through a permanently sealed seam or joint.

## Reporting a fault

In the unlikely event that you experience a problem with your campervan please contact your retailer.

It is with the retailer that your contract of sale exists and consequently they have the responsibility to ensure any complaints and warranty issues are addressed. Any Erwin Hymer Group UK approved Retailer / Service Centre are able to undertake any warrantable work at their convenience or discretion, but are not obliged to do so, if the vehicle was not purchased from them.

All Erwin Hymer Group UK products are classed as portable and therefore all work under warranty requires the campervan to be delivered and collected from the approved chosen Erwin Hymer Group UK agent.

## The cost of transporting the campervan by any means to and from the place of repair is the responsibility of the owner.

In order to comply with the terms of the above cover the following conditions must be met.

## Conditions attached to the warranty cover

- You must retain the original sales invoice for the campervan.
- All new campervans must be registered with Erwin Hymer Group UK within 6 weeks of purchase. Your retailer can forward this information to us. Please keep us informed of any name or address changes by using the Notification of Change to Name and Address form.
- The campervan must have an annual service and damp check carried out by an Erwin Hymer Group UK approved Retailer / Service Centre or NCC Approved workshop or NCC equivalent standard as set out in this handbook. Original invoices, service checklists and damp reports must be retained as proof that the annual services have been carried out in accordance with our warranty terms.
- Service intervals:
  - a) In years 1, 2, and 4 through to 9 the service must be completed no more than 60 days either side of the anniversary of the date of purchase.

- b) In Years 3 and 10 the service must be completed no more than 60 days on or before the anniversary of the date of purchase and must not exceed this date.
- c) For second owners the service in years 3 and 6 must be completed no more than 60 days on or before the anniversary of the original date of purchase. This date must not be exceeded.
- d) No service interval should exceed 14 months.
- e) **Failure to service the vehicle within the specified time limits will invalidate your warranty.**

We would recommend that you have your service carried out by an Erwin Hymer Group UK Approved Retailer/Service Centre, who are able to assist you should warranty work be required. Should you choose to have your service carried out by a non Erwin Hymer Group UK Approved agent, an additional charge may be payable by the customer to cover the second inspection.

- The campervan must be made available for repair within 6 weeks of the date of inspection for the purpose of carrying out the repair work.

Erwin Hymer Group UK reserves the right to inspect the vehicle before work commences. Failure to do this may invalidate your claim.

All defects must be assessed by an Erwin Hymer Group UK Approved Service Centre to determine the root cause of the issue. They must submit a warranty claim for our consideration, to determine if the defect is covered by the manufacturer's warranty agreement. The repair method will be agreed and any rework will be carried out at no charge to the customer.

We will not be responsible for costs incurred without prior approval via the warranty authorisation.

Warranty work may only be undertaken by an Erwin Hymer Group UK Approved Retailer/Service Centre.



- Erwin Hymer Group UK will pay the costs of remedial work to the repairer, only after approved work has been carried out. The cost of transporting, towing or moving the campervan by any means to or from the place of repair is the responsibility of the owner.
- The Policy is not retrospective and is applicable to 2019 model year campervans onwards.
- No liability will be accepted for any consequential loss, damage, costs, expenses or other claims for compensation arising which were not reasonably foreseeable by both parties when the campervan was originally purchased.
- No alteration may be made to the original construction.
- In the event of a dispute an arbitrator may be appointed, this is a discretionary service offered by us as appropriate. Should we deem it necessary to appoint an independent arbitrator, you may be required to pay a £250 deposit in advance of the inspection. If the arbitrator finds in favour of the customer then the deposit will be returned, otherwise the customer will lose their deposit.

Erwin Hymer Group UK reserve the right to inspect the campervan at any time.

## **Mains electrics**

It is recommended that you have your mains electrics system inspected by a NICEIC approved contractor every 3 years.

## **Transfer of ownership**

If you purchase this vehicle as a used vehicle it may be possible to transfer the unexpired term of the warranty cover (up to a maximum of six years commencing at the original date of purchase from new). The warranty cover for a used vehicle commences from the original date of purchase from new and is as follows:

- Three Year Manufacturer's Warranty
- A maximum of Six Years' Water Ingress and Body Integrity Warranty

The warranty is subject to the usual terms and conditions' set out in the handbook and is only transferable on payment of an administration fee. Full documentary evidence that the campervan has been serviced annually should be provided at the time of transfer, in accordance with the terms and conditions of the warranty stated in the handbook. Transfer of ownership must be completed within three months of change of legal ownership. Please complete the Notification of Change of Ownership form in your handbook. Failure to do this will negate the remaining warranty.

This warranty does not affect the purchaser's statutory rights. The warranty shall be governed and construed in accordance with the laws of England and the parties irrevocably submit to the exclusive jurisdiction of the courts of England.

For second owners the service in years 3 and 6 must be completed on or up to 60 days before the anniversary of the first owners date of purchase and must not exceed this date.

## **NON WARRANTY REPAIRS**

Should you require any replacement parts for your campervan it is necessary that you contact the Retailer from whom you purchased the campervan or any Erwin Hymer Group UK approved Service Centre and give the following information, which will help in identifying the required component:

- (i) Model and make of campervan
- (ii) VIN number
- (iii) Description of required part
- (iv) Photograph, size or diagram of required part

**Please note:** All parts must be ordered and supplied through an approved Retailer or Service Centre.

## **REMEDIAL WORK**

Erwin Hymer Group UK, together with its suppliers is continually undertaking extensive research into testing, remedial work procedures and materials such as structural bonding adhesives, gaskets and tapes. Therefore, if for any reason your new campervan is damaged or requires remedial work then we would recommend an approved Erwin Hymer Group UK Retailer or Service Centre should undertake such work.

All such work must be undertaken using only approved Erwin Hymer Group UK genuine parts, recommended structural bonding adhesive and following Erwin Hymer Group UK procedures. Erwin Hymer Group UK will also undertake to supply certain specialist repairers with the necessary spare parts. In this case, your selected repairer must contact the PARTS DEPARTMENT with all enquiries.

**Base vehicle warranty** - The base vehicle warranty cover is provided by the original manufacture. Please contact your local base vehicle retailer direct for any base vehicle warranty issues.

## **CAMPERVAN CONSTRUCTION - MAIN COMPONENTS**

The following is a brief description of the main components used in your campervan. More comprehensive descriptions can be found in the equipment manufacturers literature held in the Owner's Information Pack.

### **WINDOWS**

Windows are all of a double glazed acrylic construction.

### **INSULATION**

Erwin Hymer Group UK campervans are built to comply with thermal insulation in accordance with the European Standard BSEN 1645 part 1.



## ELECTRICAL DRAWINGS

### CAMPERVAN

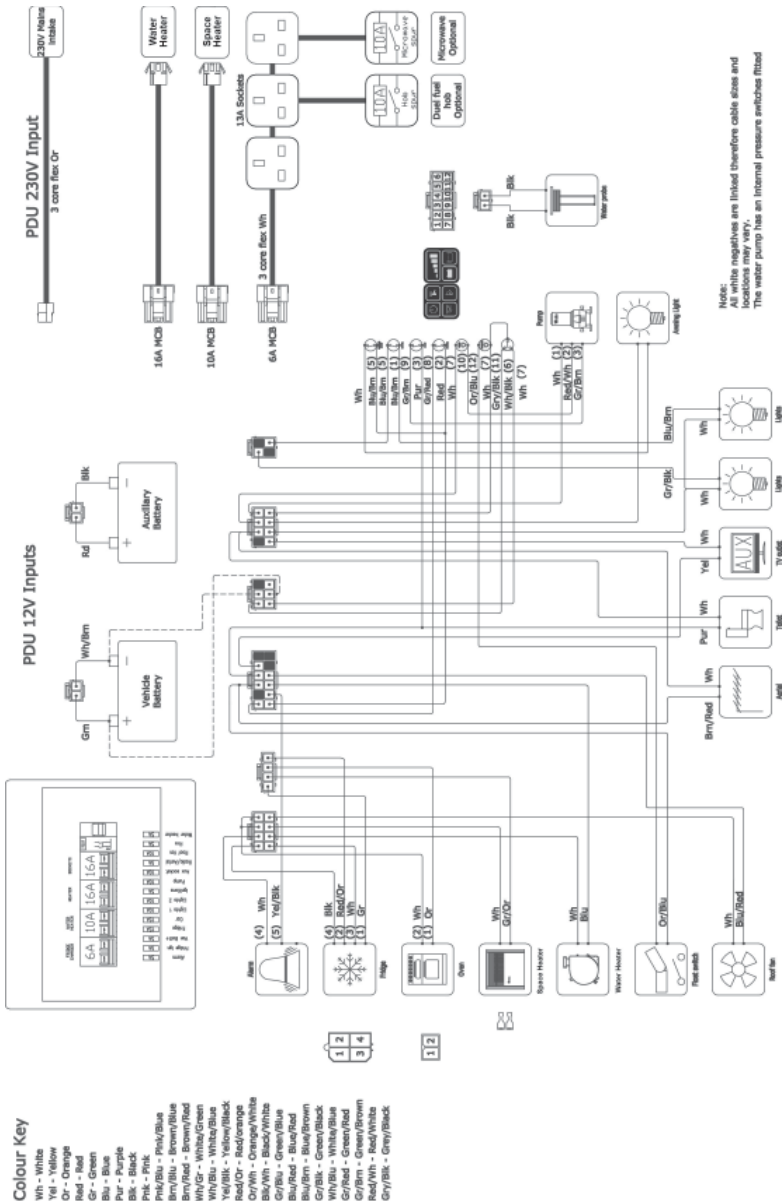



## GENERAL QUESTIONS

### **Q: Where Can I Obtain Your Latest Brochure?**

A: Our latest brochures are available from Approved Retailers or can be viewed and printed from our website [www.elddis.co.uk](http://www.elddis.co.uk). A request form can also be completed should you wish to receive a printed copy of our latest brochures.

### **Q: Why Is the Handbook Not Specific To My Model?**

A: Many of the components used in the manufacture of our campervans are identical throughout our model ranges, so we produce a generic handbook, which covers all models manufactured within a range for that season. If the literature supplied with your campervan does not answer your question then please contact your Retailer for further assistance.

### **Q. I Require Technical Or Other Information, Who Can Help Me?**

A. The majority of information you require is available through your Erwin Hymer Group UK Retailer.

### **Q - Can You Tell Me The Second Hand Price Of My Campervan?**

A - As a manufacturer we are not involved in the second hand market. You should contact a Retailer. They should be able to give some indication of market value.

### **Q: Can I Fit A Bicycle Rack To My Campervan?**

A: It may be possible to fit a bike rack, please contact your retailer for more information.

### **Q: My Interior Lights Are Not Working, What Do I Do?**

A: It is possible that all of the 230V mains electrical equipment may not be operated simultaneously. Check fuses, battery connections and power supply (master light switch). Refer to your Retailer for further assistance.

**PLEASE NOTE:** The internal lights in your campervan will not operate whilst the campervan engine is running.

### **Q: Where Can I Get Spare Parts For My Campervan?**

A: Retailers and service centres will be able to source most parts you require. For details of your nearest Erwin Hymer Group UK Retailer please refer to our Find A Retailer section on our website, or call 0371 964 2113 for assistance.

### **Q. How Many Years Will Spare Parts Be Available For My Campervan?**

A. Erwin Hymer Group UK will endeavour to supply spare parts for a campervan, for at least 8 years from new.

### **Q. Why Don't You Stock Parts At The Erwin Hymer Group UK Factory?**

A. Due to the volume of models we produce it is not possible for us to maintain stock levels of every individual component used in our manufacturing process. We do stock commonly requested items, but some items must be made to order

### **Q. What If The Parts Are No Longer Available?**

A. Where an original part is no longer available, whenever possible we will suggest a suitable alternative if it is available.

### **Q: Who Can Service My Campervan ?**

A: Any EHG UK Ltd Approved / Service Centre can undertake the service work, but this is at their discretion. We will also accept services completed by a NCC approved company, but they will NOT be able to undertake any warranty work if they are not an EHG UK Ltd Approved / Service Centre.

You may choose to have your annual service performed by an unauthorized repairer / service Centre and if you do it will be your responsibility to ensure that the service meets our requirements.

### **Q. I Am Having Trouble Booking My Campervan in For Its Service, In Line With The Requirements. What Timescale Is Acceptable?**

A. Please refer to the warranty section for the terms and conditions of servicing. We would recommend that you plan your services in advance in order to meet the requirements.

**Q. I Have A Problem With My campervan ,  
Who Can Help Me?**

A. We would always recommend that you contact your supplying Retailer. Your local Erwin Hymer Group UK approved workshop or NCC equivalent standard as set out in this handbook may be able to assist. An inspection can then take place and the necessary course of action agreed.

**Q. I Am Unhappy With The Service I Have  
Received From My Retailer/Service  
Centre, Where Do I Go From Here?**

A. We would recommend that you write to your Retailer/Service Centre, detailing your problems and requirements, requesting a response explaining how they will resolve your complaint. A copy of your letter can also be forwarded to Erwin Hymer Group UK Customer Care Department, quoting the serial number of your campervan and the name of the Retailer/Service Centre. Please be assured that we will assist your Retailer/Service Centre in resolving any problems.

**Q. Where can I obtain a Certificate of  
Conformity for my product?**

A. Original certificates of conformity are supplied with the product, duplicates are chargeable and can be requested from our customer care team. We endeavour to provide a duplicate certificate of conformity for any product manufactured from the year 2000 onwards.

If you have a product manufactured prior to the year 2000, we are no longer able to supply a duplicate certificate of conformity. Additionally, due to the age of your vehicle we are unable to account for any modifications made following the initial purchase. If you are looking to export the vehicle, we recommend the vehicle is taken for an individual vehicle approval (IVA) or similar in the country of intended registration.



## GLOSSARY

### **ABS Plastic**

Acrylonitrile Butadiene Styrene Plastic the material used for most of the large plastic components within your vehicle.

### **Actual Laden Weight**

This is the total weight of the vehicle when ready for use by the end user.

### **Awning**

This is a tent-like structure of fabric over a supporting framework, which can be attached to the side of vehicle.

### **Battery Charger**

This is required to keep a leisure battery charged. All vehicles include a charging facility which operates via the mains hook-up, and also has the ability to recharge through the base vehicle chassis or tow car's alternator.

### **Berth(s)**

Sleeping place - Refers to the number of people a vehicle can accommodate for sleeping.

### **Blown Air Heating**

A method of heating the living quarters of a vehicle by use of a fan pushing air out through a number of outlets.

### **Bunk Bed**

This is a sleeping place, usually higher up than a conventional bed. Often (but not always) this can be folded or removed to provide additional living space.

### **Butane**

Is a form of Liquefied Petroleum Gas (LPG) which normally comes in blue cylinders. This type of gas is most commonly used in the UK, although a switch to propane is advised in severely cold weather conditions.

### **Calor**

This is the main supplier of propane (red) gas cylinders and significant seller of butane (blue) gas.

### **Cassette Blind**

This is a roller blind which is fitted as part of the window assembly, often along with a flyscreen, thus giving a neat installation.

### **Cassette Toilet**

A form of chemical toilet found in modern vehicles, where the waste holding tank can be accessed and emptied from outside.

### **Chemical Toilet**

A toilet that has a compartment in which waste is treated with chemicals.

### **Control Panel**

Used as the description for the panel of electrical switches and gauges governing 12V and mains electricity systems.

### **CRiS**

This is the Central Registration and Identification Scheme. It is a voluntary scheme which registers a vehicle. Allows you to check the legitimate right to ownership of the seller of a second-hand vehicle, and helps in the recovery of stolen vehicles.

### **Dinette**

This is a popular style of seating arrangement where two seats or settees face each other across a table.

### **Earth Leakage Circuit Breaker**

ELCB Earth leakage circuit breaker - see residual current device (RCD).

### **Essential Habitation Equipment**

Those items and fluids required for the safe and proper functioning of the equipment for habitation as defined by the manufacturer of the vehicle. This includes items such as the leisure battery and gas cylinders, plus water contained in the water heater etc.

### **Flyscreens**

Mesh fittings for windows doors and roof vents, to keep out insects etc.

### **Free-Standing Table**

This is a table which, because of its leg design, can be used inside or outside.

**Full Service Pitch**

This is a pitch which has individual provision for fresh water supply and waste water disposal, in addition to mains electricity and in some cases TV aerial connection.

**Gas Cylinder**

This is a portable, pressurised container for the storage of LPG.

**Gas Locker**

Is the compartment on the caravan for the storage of gas cylinders.

**Gas Drop out Holes**

These are not part of the ventilation. LPG is heavier than air, so holes through the floor below gas-powered appliances allow any leakage of gas to exit the habitation area.

**Gas Regulator**

Safety device fitted between the gas cylinder and the gas system of a vehicle, which controls the pressure of gas being released from the cylinder.

**Grey Water**

This is the waste water from sink/shower.

**Gross Train Weight**

This is also known as Combined Weight. The maximum permitted weight of an outfit as specified by the tow vehicle manufacturer.

**Gross Vehicle Weight (GVW)**

This is the weight of the vehicle laden to its maximum, as defined by the manufacturer. See also MTPLM.

**GRP**

Is Glass-reinforced plastic, but more commonly known as glass fibre (not fibre glass, which is a trade name).

**Handbook**

This is a generic owners manual, a guide to the workings of your vehicle.

**Hardstanding**

This is a pitch which has a hard surface made of gravel, asphalt, concrete etc, instead of grass.

**Hook-Up**

This is a facility on a pitch for connection to mains electricity.

**Ingress**

The entry of water into the vehicle structure.

**Jack**

This is a device for raising the vehicle so that a wheel can be changed, for instance.

Note for caravans only - Not to be confused with corner steadies which although they are sometimes referred to as 'corner jacks' are steadying, not lifting devices.

**Kerb Weight**

This is the empty weight of a motor vehicle as defined by the manufacturer.

**Layout**

This is the interior design and details where furniture units are placed in relation to each other.

**Leisure Battery**

This supplies the power for the vehicle 12V systems and is sometimes called an auxiliary battery.

**Levelling**

The process of ensuring that a vehicle is level when sited on a pitch. It is important for comfort and also to ensure the correct functioning of the fridge and water systems.

**LPG**

Liquid Petroleum Gas, i.e. butane or propane.

**L-Shaped**

This is a term where the seating area of a vehicle is indeed L-shaped.

**Mains Hook-Up**

This is a campsite facility where you can plug into a mains electricity supply.

**Maximum Permissible Towing**

This is the maximum weight that the towing vehicle is allowed to tow.

**Maximum User Payload**

This is the maximum payload available for the user.

**MIRO - Mass In Running Order**

Weight of the vehicle equipped to the manufacturer's standard specification including essential habitational equipment.

**MTPLM - Maximum Technically Permissible Laden Mass**

The technical maximum permissible laden weight of the vehicle, this must not be exceeded.

**NCC - National Caravan Council**

The only trade association representing manufacturers, retailers and suppliers within the vehicle industry.

**Optional Equipment Payload**

A mass specified by the vehicle manufacturer for factory or pre-registration fitted options only.

**Owners' Club**

This is a group of people who usually own the same brand of vehicle and enjoy meeting up for rallies.

**Payload**

The amount you can put into a vehicle. Specifically the difference between the Maximum Technical Permissible Laden Mass (MTPLM) and the Mass In Running Order (MIRO).

**PDI**

This is an inspection undertaken by the Retailer prior to handover to the customer.

**Pitch**

A designated area of a vehicle site allocated for the use of one outfit. Most sites will be arranged with defined pitches.

**Propane**

Gas used in colder conditions and is usually supplied in red cylinders.

**RCD**

This is a residual current device and is part of the electrical system which will 'trip' if there is an electrical fault.

**Road Lights**

The external lights used while the vehicle is travelling.

**Roof Lights - See Roof Vent.****Roof Vent**

Is an opening unit in the ceiling which lets in ventilation and light, these vary in size, but the best ones will have integral blinds and flyscreens and are also called rooflights.

**Semi-Rigid Pipe work**

Is water pipes made of a semi rigid plastic and are preferable to cheaper convoluted piping which can act as a trap for germs and smells.

**Serial number**

This is a unique serial identification number for a vehicle.

**Slats**

Sometimes used for beds and can improve ventilation to mattress cushions.

**Space Heater**

This is a type of heating equipment for the living quarters. Modern units fitted offer gas and mains-operation.

**Speed Rating**

This is the maximum speed at which a tyre may be used, as marked on its sidewall.

**SMMT**

Society of Motor Manufacturers and Traders.

**Torque Wrench**

A form of spanner used to set nuts and bolts to a specified degree of tightness. It is recommended for adjustment of wheel fixings on vehicle.

**Towing Limit**

See manufacturer's braked towing limit and manufacturer's unbraked towing limit.

**User Payload**

The weight of all items carried in the vehicle.

**U-Shaped Settee**

Usually a reference to seating that literally is 'U' shaped.

**Vehicle Kerb weight**

The weight of the tow car often indicated in the manufacturers specifications..

**VIN - Vehicle Identification Number**

This is a unique vehicle identification number. All Cars and motorhomes should carry a VIN. Caravans are not obliged to, but the serial number is used as part of the CRiS voluntary registration scheme.

**Warranty**

Are the terms and conditions that spell out your rights with regards to servicing, repair or replacement of parts as provided by the manufacturer.

**Wild Camping**

Term used for staying overnight away from a campsite. Illegal in many countries, but permission may be granted by individual landowners.

## CAMPERVAN ANNUAL SERVICE RECORD

In order to ensure your warranty remains valid an annual service must be carried out in accordance with the requirements of this handbook. You are responsible for any charges incurred for the service of your vehicle. If the annual service is performed by an authorised Erwin Hymer Group UK Approved Retailer / Service Centre or NCC Approved Workshop then Erwin Hymer Group UK Limited deems that the service has been performed correctly.

You may choose to have your annual service performed by an unauthorised repairer / service centre and if you do it will be your responsibility to ensure that the service meets our requirements.

We will ask you to provide a copy of the following documentation:

- Damp report
- Annual Habitation Service check list (to the minimum standard set out in this handbook)
- Invoice / dated service stamp

If the Annual Service has not been performed in accordance with the requirements in this handbook your warranty will be invalidated, however this will not affect your legal or statutory rights as a customer.

Erwin Hymer Group UK will not pay any unapproved Service Centre for the undertaking of any warranty work.

Minimum service requirements

The service must be undertaken by suitably qualified personnel.

A full damp test check should be undertaken and damp readings recorded.

A service check must be performed to the minimum standards set out below.

### Annual Habitation Service check list

#### UNDERBODY

| Item   | Condition |
|--|-----------|
| Under slung tanks and pipes - check condition and security |           |

#### ELECTRICAL SYSTEMS

| Item   | Condition |
|--|-----------|
| Check the leisure battery is being charged from both the engine when running, or with a multi-tester and the mains charger |           |
| Leisure Battery (if fitted) - check condition of the battery & its compartment   |           |
| Interior lighting & equipment - check operation and fuse rating  |           |
| Awning light - check operation   |           |
| Wiring earths - check for defects on all ELV circuits (Visual)   |           |
| LV inlet plug & extension lead – check condition & resistance across pins  |           |
| Earth Bonding - visual inspection  |           |

# SERVICE DOCUMENTS

## ELECTRICAL SYSTEMS (continued)

| Item   | Condition |
|--|-----------|
| RCD unit - check operation of RCD test button and operations of MCBs |           |
| 230V appliances - check operation                                    |           |

## GAS SYSTEMS

| Item  | Condition |
|---|-----------|
| Regulator and gas hose - check age performance and security   |           |
| Perform a gas pressure check                                  |           |
| LPG Tank (if fitted) - check security                         |           |
| Flame failure devices - check operation                       |           |
| Gas dispersal holes - check they are clear from obstructions. |           |

## APPLIANCES (check gas and electric operation)

| Item                            | Condition |
|---------------------------------|-----------|
| Hob - check operation           |           |
| Oven - check operation          |           |
| Grill and fan - check operation |           |
| Fridge - check operation        |           |
| Water boiler – Check operation  |           |
| Heater - check operation        |           |

## WATER SYSTEM

| Item  | Condition |
|---|-----------|
| Water pump & pressure switch - check operation  |           |
| Taps, pipes - check operation   |           |
| Water system - check for leaks  |           |
| Water Tanks (if fitted) - check security of all water tanks including underslung tanks. |           |
| Toilet - check security, operation of flush pump and free from obstructions.            |           |
| Drain down the system when checks are complete.   |           |

## VENTILATION

| Item  | Condition |
|---|-----------|
| Rooflights - check all are free from obstructions, cracks and have a free air flow                |           |
| Floor vents - remove protective cover and check they are clear from obstruction then refit covers |           |

## FIRE & SAFETY

| Item   | Condition |
|--|-----------|
| Smoke and carbon dioxide detectors - check for operation via the test buttons fitted, check battery condition. |           |
| Fire Extinguisher (if fitted) - check it is still within date  |           |
| Fire Blanket (if fitted) - check it is still within date   |           |
| Habitation doors operation   |           |

## BODYWORK

| Item   | Condition |
|--|-----------|
| Doors and windows - check all catches are present and operating correctly. |           |
| Blinds and flyscreens - check condition and operation                      |           |
| Roof - check condition of roof.  |           |
| Cab seats - check condition of the seats and seats belts                   |           |
| Floor - check condition of floor   |           |
| Furniture - check condition of the furniture                               |           |
| Damp Test - undertake a damp test and record all readings taken.           |           |
| Lubricate all locks  |           |

**ANNUAL HABITATION SERVICE RECORDS**

|                                     |            |
|-------------------------------------|------------|
| <b>ANNUAL SERVICE RECORD</b>        |            |
| CAMPERVAN MODEL .....               |            |
| VEHICLE IDENTIFICATION NUMBER ..... | YEAR ..... |

|   |
|---|
| <b>1st SERVICE</b>  |
| DATE:   |
| RETAILERS STAMP:  |
| I/We certify that an annual service has been carried out in accordance with the manufacturers' and NCC recommendations. |

|   |
|---|
| <b>2nd SERVICE</b>  |
| DATE:   |
| RETAILERS STAMP:  |
| I/We certify that an annual service has been carried out in accordance with the manufacturers' and NCC recommendations. |

|   |
|---|
| <b>3rd SERVICE</b>  |
| DATE:   |
| RETAILERS STAMP:  |
| I/We certify that an annual service has been carried out in accordance with the manufacturers' and NCC recommendations. |

|   |
|---|
| <b>4th SERVICE</b>  |
| DATE:   |
| RETAILERS STAMP:  |
| I/We certify that an annual service has been carried out in accordance with the manufacturers' and NCC recommendations. |

|   |
|---|
| <b>5th SERVICE</b>  |
| DATE:   |
| RETAILERS STAMP:  |
| I/We certify that an annual service has been carried out in accordance with the manufacturers' and NCC recommendations. |

|   |
|---|
| <b>6th SERVICE</b>  |
| DATE:   |
| RETAILERS STAMP:  |
| I/We certify that an annual service has been carried out in accordance with the manufacturers' and NCC recommendations. |



SERVICE DOCUMENTS

**7th SERVICE**

DATE:

RETAILERS STAMP:

I/We certify that an annual service has been carried out in accordance with the manufacturers' and NCC recommendations.

**8th SERVICE**

DATE:

RETAILERS STAMP:

I/We certify that an annual service has been carried out in accordance with the manufacturers' and NCC recommendations.

**9th SERVICE**

DATE:

RETAILERS STAMP:

I/We certify that an annual service has been carried out in accordance with the manufacturers' and NCC recommendations.

**10th SERVICE**

DATE:

RETAILERS STAMP:

I/We certify that an annual service has been carried out in accordance with the manufacturers' and NCC recommendations.

**11th SERVICE**

DATE:

RETAILERS STAMP:

I/We certify that an annual service has been carried out in accordance with the manufacturers' and NCC recommendations.

**12th SERVICE**

DATE:

RETAILERS STAMP:

I/We certify that an annual service has been carried out in accordance with the manufacturers' and NCC recommendations.

**13th SERVICE**

DATE:

RETAILERS STAMP:

I/We certify that an annual service has been carried out in accordance with the manufacturers' and NCC recommendations.

**14th SERVICE**

DATE:

RETAILERS STAMP:

I/We certify that an annual service has been carried out in accordance with the manufacturers' and NCC recommendations.



## NOTIFICATION OF CHANGE OF OWNERSHIP

If you purchase this vehicle as a used vehicle it may be possible to transfer the unexpired term of the warranty cover (up to a maximum of six years commencing at the original date of purchase from new). Please refer to the warranty section of the handbook for terms and conditions.

Please complete the attached form and post it to us along with the following information:

- A copy of the V5 registration form
- A copy of the habitation service handbook displaying a complete and up to date service history, including service checklist and damp report.
- Please contact the customer care team to arrange payment.

Transfer of ownership must be made within the first three months of any change of legal ownership in order for the warranty cover to remain valid.

Erwin Hymer Group UK Limited Customer Care

Delves lane

Consett

County Durham

DH8 7PE

www.elddis.co.uk

Email documents to [customer.care@erwinhymergroup.co.uk](mailto:customer.care@erwinhymergroup.co.uk) payment can be taken over the phone

## NOTIFICATION OF CHANGE OF OWNERSHIP

**Previous owner details** (if known):

Name: .....

Address: .....

.....

..... Post code: .....

Email: .....

**New owner details:**

Name: .....

Address: .....

.....

..... Post code: .....

Email: .....

Daytime telephone number: ..... Date of purchase: .....

**Details of Campervan:**

Range: ..... Model: .....

Vehicle identification number (17 digits): .....

\* In order for you warranty to remain valid, your campervan must have been serviced annually by an Approved Retailer / Service Centre, NCC Approved Workshop or NCC equivalent standard as set out in this handbook.

If you do not want to receive information about products and services from Erwin Hymer Group UK,

please tick.



**NOTIFICATION OF CHANGE TO NAME AND ADDRESS**

In order that we can provide you with the very best level of service we ask that you keep us informed of any changes to your contact details.

Should your details change please complete the attached form and post to us:

Erwin Hymer Group UK Limited Customer Care  
Delves Lane  
Consett  
County Durham  
DH8 7PE  
www.elddis.co.uk  
Email documents to customer.care@erwinhymergroup.co.uk

.....<

**NOTIFICATION OF CHANGE TO NAME AND ADDRESS**

**Previous details:**

Name: .....

Address: .....

.....

..... Post code: .....

Email: .....

**New details:**

Name: .....

Address: .....

.....

..... Post code: .....

Daytime telephone number: ..... Date of purchase: .....

Email: .....

**Details of your Campervan:**

Range: ..... Model: .....

Vehicle identification number (17 digits): .....

If you do not want to receive information about products and services from Erwin Hymer Group UK, please tick.



**A**

- Alarm system ..... 9-1
- Automatic Charging System ..... 7-2

**B**

- Battery Installation ..... 7-1
- Battery Maintenance ..... 7-1, 11-1
- Bed make up ..... 8-44
- Bicycle racks ..... 3-2

**C**

- Care of your Campervan ..... 10-1
- Charging System ..... 7-2
- Code of Practice
  - Remedial Work ..... 12-4

**D**

- Door flyscreen ..... 8-35

**E**

- Electrical System ..... 7-1
- Electricity ..... 6-1
  - 12v Systems ..... 6-1
    - Connecting To Mains Supply .. 6-1
    - Disconnecting Mains Supply .. 6-2
  - Generator/Charger ..... 6-1
  - Mains Supply ..... 6-1
  - Overseas Electrical
    - Connection ..... 6-2
  - Power Supply Charger ..... 6-1

**G**

- Gas ..... 6-6
  - Connection ..... 6-6
  - Regulator ..... 6-6
- Gas Safety Advice ..... 6-3
- Generators / Charger ..... 7-2
- Glossary ..... 16-1

**I**

- Insulation ..... 13-1

**L**

- Levelling ..... 5-1
- Loading ..... 3-1

**M**

- Mains Unit ..... 7-2
- Campervan Construction -  
Main Components
  - Windows ..... 13-1

**N**

- Notification of Change
  - of Ownership ..... 18-1
- Notification of Change to
  - name and address ..... 19-1

**R**

- Refrigerator ..... 8-23

**S**

- Safety, general ..... 2-1
- Security ..... 9-1
- Service records ..... 17-4
- Site Regulations ..... 5-1
- Storage
  - Long Term & Winter ..... 11-1

**T**

- Taps ..... 8-36
- Toilet
  - Thetford C260 ..... 8-38

**V**

Ventilation ..... 2-2

**W**

Water System ..... 6-7

Wiring diagram ..... 14-1